

ENGINEERING
YOUR SPRAY SOLUTION



➤➤ AGRICULTURAL SPRAY NOZZLES AND ACCESSORIES

for spray applications in agriculture | Catalogue L 2022

AGRICULTURE

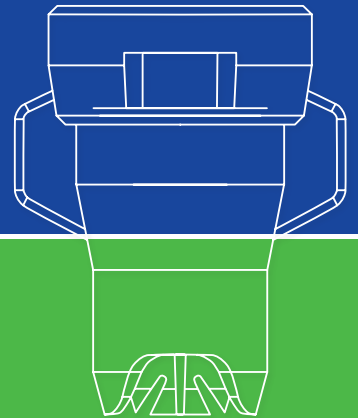



LECHLER AGRICULTURAL
NOZZLES –
GOOD FOR YOUR
CROP, GOOD FOR
THE ENVIRONMENT

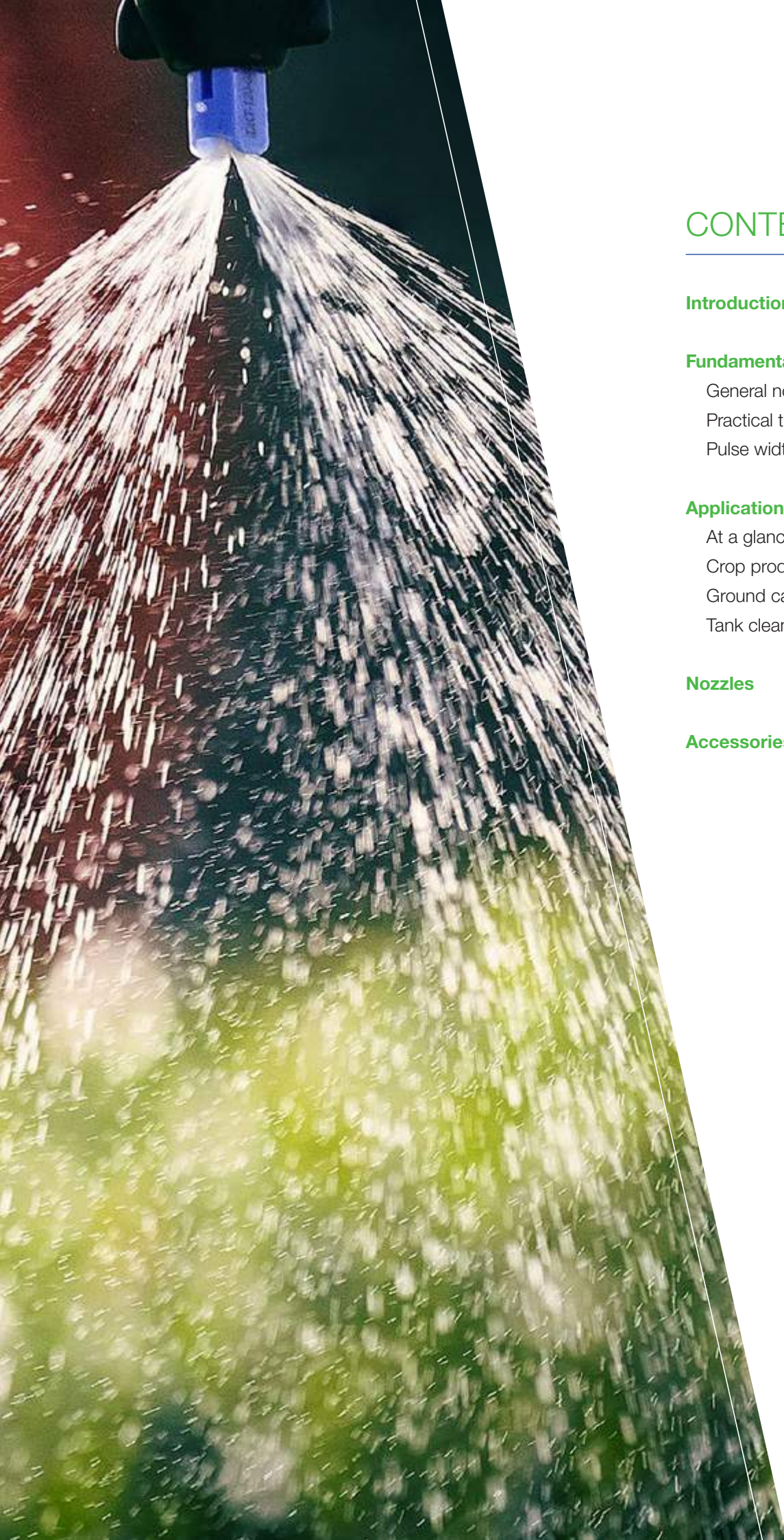

CONTENTS

Introduction 4

Fundamentals of nozzle technology

General nozzle technology 6

Practical tips 14

Pulse width modulation 16

Applications

At a glance 18

Crop production 20

Ground care 28

Tank cleaning 36

Nozzles 44

Accessories 116



LECHLER AGRICULTURAL TECHNOLOGY – LEADING IN DRIFT-REDUCING TECHNOLOGY AND USER-FRIENDLY SOLUTIONS



Lechler is a world leader in nozzle technology. For over 140 years, we have pioneered numerous groundbreaking developments in the field of nozzle technology. Thanks to our decades of experience with drift-reducing technology, we have been able to make a significant contribution to more gentle and precise application of plant protection products.



We developed the ID 120-05 as early as the 1990s – the first JKI-approved nozzle with 90% drift reduction – and therefore laid down a marker for the future direction. Just a few years later, the PRE (VA for Syngenta) already made it possible to achieve a 95% drift reduction for field spraying. Further user-friendly solutions followed at short intervals, such as the patented IDTA injector that can be removed without tools.

In Europe, Lechler has been the number one for nozzle technology for a long time now. However, we do not just see ourselves as a nozzle manufacturer, but above all as a partner in efforts to achieve both environmentally-friendly and efficient agriculture. This is also particularly true for the large growth markets in the CIS states and India, where we are already represented by subsidiary companies and a dense sales network.



FUNDAMENTALS OF NOZZLE TECHNOLOGY

GENERAL NOZZLE TECHNOLOGY

Flow rate

The flow rate of a nozzle changes as a function of the spray pressure. Expressed in simplified terms, the flow rate (l/min) is doubled if the spray pressure (bar) is quadrupled.

The following formula applies:

$$\dot{V}_2 = \sqrt{\frac{p_2}{p_1}} \times \dot{V}_1 \quad [\text{l/min}]$$

Density

All table values for flow rate are based on water (density 1.0 kg/l), if not otherwise specified. In the case of liquids with a different density, the specified conversion factors must be taken into account.

Conversion factors for different liquid densities

Density of sprayed liquid	0.84	0.96	1.00 Water	1.11 Urea	1.24 ASL	1.28 UAN (28) UAN +S	1.32 UAN (30)	1.38 NP- solution	1.44	1.50
Conversion factor	1.09	1.02	1.00	0.95	0.90	0.88	0.87	0.85	0.83	0.81

The following applies to conversion:

$$\text{Flow rate Water (table value)} \times \text{Conversion factor} = \text{Actual flow rate of the medium}$$

Identification of Lechler nozzles

The properties of Lechler nozzles are specified in accordance with international standards and contain the following information:

- Nozzle series
- Spray angle
- Nozzle size
- Material

Lechler nozzles are color-coded in accordance with ISO 10625. Each nozzle color is assigned to a defined flow rate. This information is also contained in the nozzle size, e.g. -03 stands for a flow rate of 0.3 US gallons per minute at 40 psi. The nozzle material is coded with the letters S (stainless steel), M (Brass) or C (Ceramic).



Color coding in accordance with ISO standard 19732 for filters since 2011

Old color code Lechler	Old color code ARAG	ISO 19732	Mesh
		New color code	
yellow		red	25
	white	red	32
	blue	blue	50
red		blue	60
	gray	yellow	80

Conversion table for original and new ISO color codes.

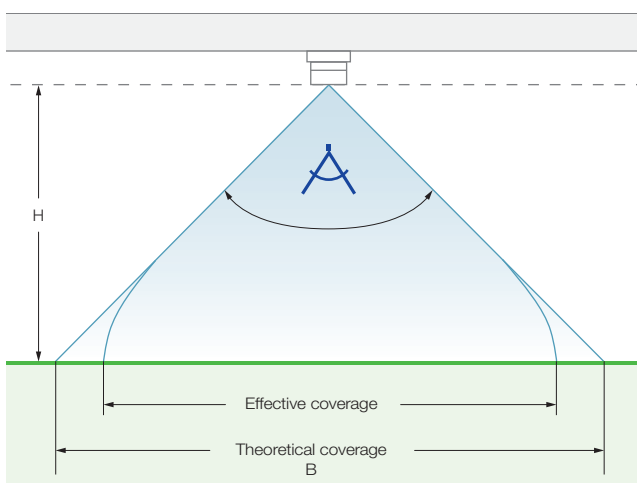
Coverage

The theoretical coverage (B) of a nozzle is essentially determined by the spray angle and spray height (H) from the target surface. Depending on nozzle series and nozzle size, the spray pressure can also influence the spray angle and distribution accuracy.

Prerequisites for uniform liquid distribution in the spraying system are compliance with the recommended spray pressure at the nozzle as well with the minimum spray height for a given nozzle spacing.

Due to the physically caused collapse of the jet, the effective coverage is less than the theoretical coverage stated below particularly with low pressures and large spray heights.

Spray angle	Theoretical coverage B for different spray heights H in cm											
	10	15	20	25	30	40	50	60	70	80	100	120
20°	3.5	5.3	7.1	8.8	10.6	14.1	17.6	21.2	24.7	28.2	35.3	42.0
30°	5.4	8.0	10.7	13.4	16.1	21.4	26.8	32.2	37.5	42.9	53.6	64.0
45°	8.3	12.4	16.6	20.7	24.9	33.1	41.4	49.7	58.0	66.3	82.8	99.0
60°	11.6	17.3	23.1	28.9	34.6	46.2	57.7	69.3	80.8	92.4	115.0	138.0 ¹
90°	20.0	30.0	40.0	50.0	60.0	80.0	100.0	120.0	140.0	160.0	200.0	240.0 ¹
120°	34.6	52.0	69.3	86.6	104.0	139.0	173.0	208.0	242.0	277.0	346.0 ¹	416.0 ¹
140°	55.0	82.4	110.0	137.0	165.0	220.0	275.0	330.0 ¹	385.0 ¹	440 ¹	550.0 ¹	660.0 ¹

¹ Large deviation between effective and theoretical coverage.





Nozzle arrangement in the system

Nozzle arrangement for flat spray nozzles

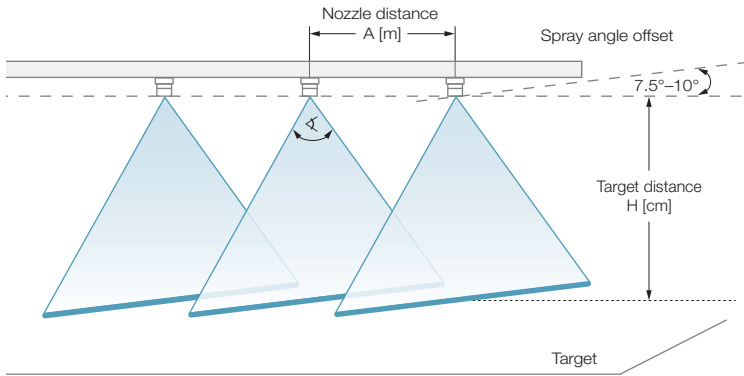

In order to avoid mutual spray jet interference, the jet plane of flat spray nozzles is rotated by about 7.5° to 10° with respect to the pipe axis. This takes place automatically with Lechler diaphragm valves and eyelet connectors with TWISTLOC/MULTIJET bayonet cap. The Lechler nozzle aligner gauge (order No. **065.231.02**) is available for systems with screw/union nut fastening.

Nozzle arrangement for hollow cone nozzles

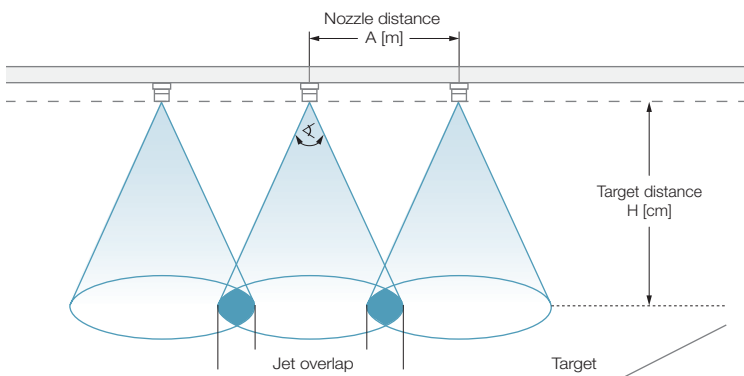

Hollow cone nozzles must be arranged so that the jet cones just overlap shortly before the target surface.

Recommended spray height (min. – optimal – max. [cm]) above the target surface depending on nozzle series, spray angle and nozzle spacing

Nozzle spacing A [m]	Target surface distance (H) 															
	Flat fan nozzles													Hollow cone nozzles	Stream jet nozzles	
	IDTA/ID/IDKT/AD/DF	PRE	XDT	IDK/IDKN	ID3/IDK/AD/LU	LU	ST	QS	ST	VR	FD	FT	FT	TR/ITR	FL	FS
Spray angle	120°	130°	130°	120°	90°	120°	110°	80°	80°	130°	130°	90°	140°	80°	160°	100°
1.0	–	–	–	–	–	–	–	–	–	–	–	–	75 ¹	–	–	–
0.5	40-50-60	40-50-60	30-60	40-50-60 ² / 90	60-75-90	40-50-60	40-50-60	60-75-90	60-75-90	50-70	50-70	60-75-90 ¹	40 ¹	–	100	80-90-100
0.25	20-35	–	–	20-45	30-45	20-35	20-35	30-45	30-45	–	–	30-45 ¹	–	50-65-80	–	–

¹ The spray height of flood nozzles is also influenced by the alignment. At least single spray width overlap is required for uniform lateral distribution. Rule of thumb: With nozzle spacings other than those stated (A), the ratio of nozzle spacing to optimum spray height is 1:1 for flat spray nozzles with a spray angle of 110°/120° and 1:1.5 for nozzles with a spray angle of 80°/90°.

² IDK 120-06 to -10.

Calculation formula for arable crop applications

Application parameters for system arrangement

The table values in the technical part of the catalog apply for field spraying booms with a lateral nozzle spacing of $A = 0.5$ m. The adjacent formulas apply for other lateral nozzle spacings.

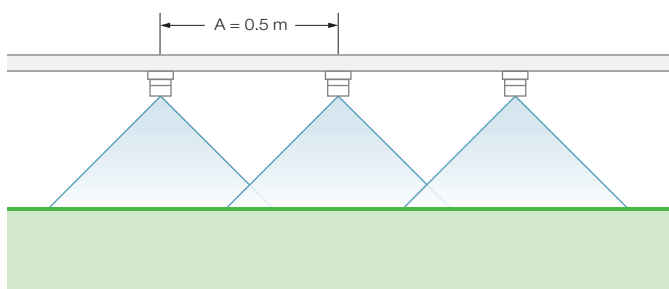

As a general rule:

Of the four parameters sprayer speed [km/h], application rate [l/ha], flow rate [l/min] and nozzle spacing [cm], three are normally known. The frequently unknown variables [l/ha] and [l/min] are also calculated using the adjacent formulas.

Liter per hectare rate M [l/ha]

$$M = \frac{600 \times \dot{V}}{A \times v_F}$$

Flow rate/nozzle \dot{V} [l/min]

$$\dot{V} = \frac{1}{600} \times M \times A \times v_F$$

Lateral nozzle spacing A [m]

Sprayer speed v_F [km/h]

Example for calculation of flow rate per nozzle:

$A = 1$ m, $v_F = 6$ km/h, $M = 400$ l/ha

$$\dot{V} = \frac{400 \times 1 \times 6}{600} = 4 \text{ l/min}$$

Application parameters for band spraying

Band width B [m]

Lateral nozzle spacing or row spacing A [m]

$$\frac{B}{A} \times 100 = \begin{array}{l} \text{treated (sprayed) area as a} \\ \text{percentage share} \\ \text{of total gross covered area} \end{array}$$

Calculation of the actual application quantity for band or row spraying is based on the ratio of the treated area and the area to be driven over.

The application quantity in l/ha corresponds to the percentage (e.g. 40 %) of the application quantity for broadcast spraying.

Example:

$$\frac{0.2}{0.5} \times 100 = 40 \%$$

Good to know

The apps for Lechler agricultural nozzles make selection and use of the optimum nozzle even easier. Find out more here: www.lechler.com/de-en/service/apps



Nozzle
calculator app





Calculation formula for viticulture, orchard and special crops

Sprayer equipment with nozzles of the same size

The flow rate of the individual nozzles is calculated by dividing the total nozzle output by the number of working nozzles. The nozzle size and pressure are determined from the flow rate on the basis of the tables (see Page 72–81). The working

width corresponds to the distance between the driving lanes, i.e. it corresponds to the row spacing if every driving lane is used. If only every second driving lane is used, the working width corresponds to double the row spacing.

$$\dot{V} = \frac{M \times v_F \times B}{600}$$

\dot{V} = Total nozzle output [l/min]

M = Liter per hectare rate [l/ha]

v_F = Sprayer speed [km/h]

B = Working width/row spacing [m]

Sprayer equipment with nozzles of different sizes

If nozzles with different sizes are used simultaneously in one sprayer, the nozzle size is first determined that would be obtained in the case of equipment with nozzles offering identical performance.

The number of nozzles of the next-smaller nozzle size is taken into account corresponding to the total number of nozzles. In order to achieve the given liquid application rate (required value), the pressure must be increased in accordance with the adjacent formula.



$$\text{Pressure setpoint} = \text{Pressure actual value} \times \left[\frac{\text{Total nozzle output setpoint}}{\text{Total nozzle output actual value}} \right]^2$$

Example:

With a sprayer speed of 6.5 km/h, the required delivery is 600 l/ha. The working width is 2.0 m. The total nozzle output of the sprayer is then:

$$\frac{600 \times 6.5 \times 2.0}{600} = 13.0 \text{ l/min}$$

If 10 nozzles with the same nozzle size are used, the flow rate of each nozzle is $13.0 : 10 = 1.3 \text{ l/min}$.

Select nozzle/pressure according to spray table:

ID-90-02/yellow at 8.0 bar

Instead of the nozzle ID-90-02, the lower and two upper nozzles should be fitted with the next-smaller nozzle size 6 x ID-90-015/green on both sides of the sprayer. The total nozzle output (actual value) is as follows at 8.0 bar (actual value):

$$(6 \times 0.96 + 4 \times 1.30) \text{ l/min} = 10.96 \text{ l/min}$$

The pressure setpoint to be set for 600 l/ha (setpoint) is then:

$$8 \times \left[\frac{13.0}{10.96} \right]^2 = 11.2 \text{ bar}$$

Good to know

The apps for Lechler agricultural nozzles make selection and use of the optimum nozzle even easier. Find out more here: www.lechler.com/de-en/service/apps



Nozzle
calculator app





Quality means being measured by results



Approved Lechler nozzles for arable crops as well as for viticulture, orchard and specialty crop applications always reliably meet the requirements of the Julius Kühn Institut (JKI) and other international standards.

Lechler nozzles therefore fulfill all prerequisites of German and European plant protection legislation as well as ISO 16119 (Environmental requirements for sprayers) and ISO 16122 (Inspection of sprayers in use).

Droplet sizes

The droplet sizes for nozzles used for the application of pesticides are usually characterized by the Mean Volumetric Diameter (MVD) and are specified in micrometers (μm). An MVD of 400 μm means that 50 % of the volume is sprayed in the form of droplets larger than 400 μm and 50 % in the form of droplets smaller than 400 μm . This means that not all droplets are of the same size.

When classifying the droplet spectrum of a nozzle into the classes “fine”, “medium”, and “coarse”, etc., Lechler worked according to the specifications of BCPC (British Crop Production Council) until 2019. Since 2020, the spray pattern has been assessed in accordance with the new ISO standard 25358.

This makes it easier to compare measurements, even if the measurement technology and thus possibly also the absolute measured values (μm) differ. The reference nozzles, pressures and uniform color coding of the droplet size classes have been redefined. The droplet size class “Ultra coarse” has been added. As a result, the ranges of the droplet size classes have been redefined and are now much smaller in comparison with the classification according to BCPC.

What does this change for the farmer?

The nozzles and also the droplets and wetting remain the same. The only change is in the referencing system. The classification of the droplet size classes for the injector nozzles thus changes. This led to a shift of 1 to 2 droplet size classes in the direction of coarser (e.g. previously “Medium” and now “Coarse” or “Very coarse”). The additional droplet size class “Ultra coarse” divided the old droplet size class “Extremely coarse” into two classes.

Good biological effect with “Coarse”, “Very coarse” or even “Extremely coarse”?

With an injector nozzle and a water volume of e.g. 200 l/ha with an MVD of 400 μm (0.4 mm), this spray pattern was classified as “Coarse” according to the BCPC classification; this is “Very coarse” according to ISO 25358 from 2020. Coverage is ensured by half of the water quantity (100 l/ha) in the form of coarse, medium and fine droplets below the mean value of 400 μm . In comparison, very coarse and extremely coarse droplets transport more active ingredient to the target.

Droplet size classification

BCPC (up to 2019)	ISO 25358 (from 2020)	
VF	VF	Very fine
F	F	Fine
	M	Medium
M	C	Coarse
C	VC	Very coarse
VC		
UC	EC	Extremely coarse
	UC	Ultra coarse

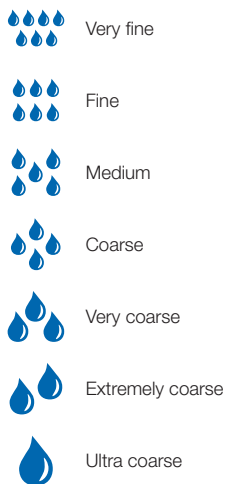

Conversion from BCPC to ISO 25358.

The result

Good biological effect and good drift reduction

Even if the classification “Very coarse” is often compared with raindrops, their droplet size of 2,000–3,000 μm (2–3 mm) means that the latter are many times larger than the droplets from a nozzle with an extremely coarse droplet size. The above table/graphic representation compares the two measuring methods and therefore allows a direct comparison between the previous (BCPC) and new methods (ISO 25358).



FUNDAMENTALS OF NOZZLE TECHNOLOGY

PRACTICAL TIPS

Filter correctly

Malfunctions during operation caused by coarse particles can be prevented by use of the correct filter system. In order to protect the nozzle filter, we recommend selecting a mesh filter in the line strainer which is one category finer. The recommendations for the mesh size (M) of the nozzle cup strainer are provided in the spray tables according to nozzle size.

Scheme for selecting the mesh size using the example of a field sprayer:

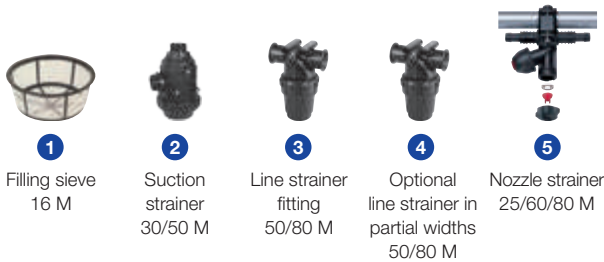
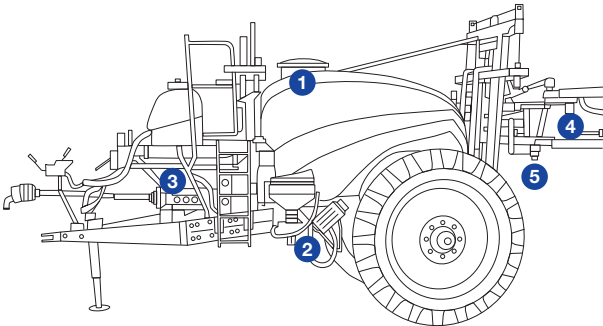

Scheme for selecting the mesh size using the example of a sprayer for viticulture and orchards:

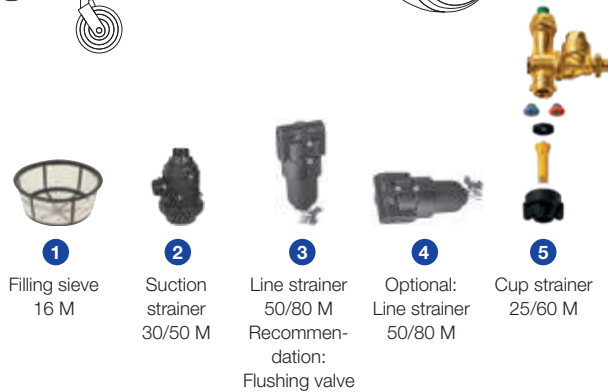
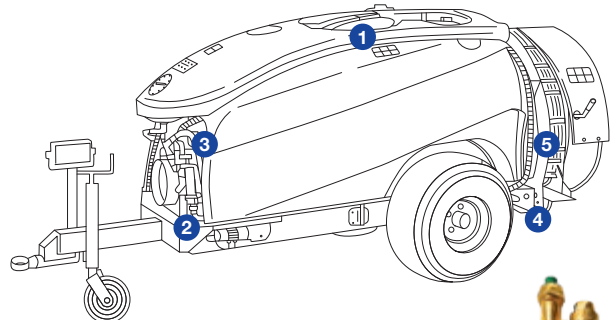

Avoid nozzle blockages

Properly functioning equipment is a prerequisite for successful crop protection. Clogged nozzles mean lost time and can lead to incorrect spray application. The following tips help to avoid mistakes.

Correct procedure:

- Observe the specified order when producing the spray mixture
- Always add only one product at a time
- Allow sufficient time to dissolve
- The mixer must guarantee good and homogeneous mixing of the plant protection product
- Match the filter in the equipment to the nozzle size
- Clean after use, e.g. with continuous internal cleaning
- Pay attention to water quality in relation to solubility of plant protection products

Troubleshooting for nozzles

Nozzle clogged	clean
Nozzle damaged	replace
Nozzle worn	replace
Wrong nozzle (type/size)	replace
Filter clogged	clean
Diaphragm valve defective	replace

Nozzle wear

Nozzles become worn even if used properly and thus have a limited service life.

Wear is determined by factors such as spray pressure, abrasiveness of the spray fluid and the nozzle material. Damage to the nozzle tip, due to incorrect cleaning or handling for example, must be avoided under all circumstances.

A simple way of determining the wear of nozzle tips is to gauge the flow rate using a measuring jug, stop watch and pressure gauge on the nozzle line (see below). The flow rates of the used nozzles are compared here with the table values of new nozzles of the same size. The nozzles in use should be replaced as soon as the actual flow rate exceeds the table value by more than 10% in field sprayers and more than 15% in air blast sprayers.

All table values in this catalog specify the flow rates of new nozzles.

In addition, equipment testing of field sprayers on a nozzle test bench also provides information about the nozzle condition in relation to cross distribution, whereby the quality of cross distribution and the change in flow rate may be interdependent with respect to the calculated coefficient of variation.

The wear resistance of the nozzle material increases in the following order:

Brass → Stainless steel → Plastic → Ceramic



Correct output measurement

A sprayer will deliver the desired product quantity per hectare only if it is correctly adjusted. The easiest method for checking this yourself is measurement of the individual nozzle output. A nozzle used in field sprayers is considered to be worn when the individual nozzle output is 10% above the value in the spray table. The pressure range and pressure drop must be taken into account.

Output measurement is also necessary for flow-controlled devices.
Source: Bildungswerkstatt Mold, Pichler Herbert

Measuring the driving speed

60 s = 6.0 km/h
45 s = 8.0 km/h
36 s = 10.0 km/h

Example:

$$\frac{100 \text{ m} \times 3.6}{45 \text{ s}} = 8.0 \text{ km/h}$$

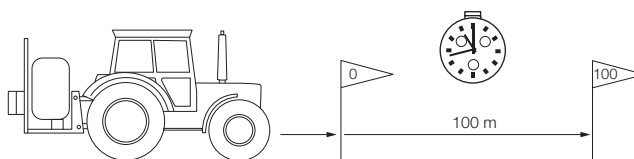

Thread table and pipe diameters

Compatibility of pipe threads			Female thread			
			DIN EN 10226	ISO 228	NPT	
Male thread	DIN EN 10226	R	Rc	Rp	G	
	ISO 228	G	●	●	● ¹	
	NPT					●

Code for pipe diameters:

20 mm 20 mm
1/2" 21 mm
25 mm 25 mm
3/4" 27 mm
1" 34 mm

● = compatible
Taper thread: R, Rc, NPT
Parallel thread: Rp, G

¹ Leakage possible! Flat seal recommended.



FUNDAMENTALS OF NOZZLE TECHNOLOGY

PULSE WIDTH MODULATION

Pulse width modulation (PWM) is a current application trend for plant protection products. Whereas conventional nozzles are always open, a solenoid valve opens and closes the valve 10 to 30 times per second here. The frequency is either pre-defined or is defined in the basic settings. It is not decisive for the nozzle selection.

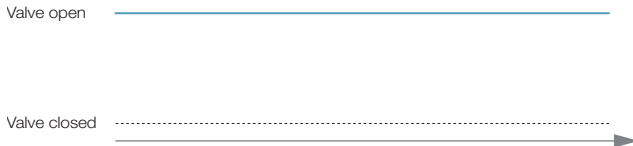

Duty cycle (DC) 100%:
The valve is continuously open.

The duty cycle (DC) specifies the time ratio between open and closed valve as a percentage. It is an important variable for good lateral and longitudinal distribution of the sprayed liquid. The valve is open continuously with a duty cycle of 100% – like with conventional nozzles. If the duty cycle is reduced to 50%, the flow rate is also halved – with a constant pressure.

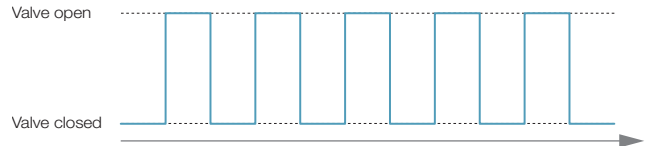

Duty cycle (DC) 50%:
The nozzle is alternately closed and open for equal periods of time.

An example: With a duty cycle (DC) of 50%, the applied quantity for nozzle size 06 (gray) corresponds to the quantity of a nozzle size 03 (blue) without PWM. Nozzles are ideally used with a duty cycle (DC) of 30%–100%.

PWM technology is particularly advantageous for the following applications:

- Individual nozzle switching and control with variable flow rate
- Constant droplet size and application quantity with variable working speed
- Drift reduction and uniform wetting quality with constant droplet size
- Curve compensation to avoid underdosing and overdosing at the outer and inner parts of the boom, e.g. when driving round obstacles
- Variation of application quantity for area-specific application
- Large flow rate control range of a nozzle without a significant change in the droplet size
- Spot spraying – for precise small-area application of plant protection products

Tested and approved

Lechler agricultural nozzles were tested with PWM valves in an extensive test program. JKI approvals for PWM valves with different nozzle types are available. The drift reduction is based on the nozzle entries in the “Register of loss-reducing equipment”: same drift reduction class for duty cycle (DC) 100% or one drift reduction class lower for “pulsing”.

Lechler flat fan, double flat fan and liquid fertilizer nozzles are generally suitable for PWM. This includes the series LU, AD and XDT without injector as well as ID, IDTA, IDK/IDKN and IDKT with injector and liquid fertilizer nozzles FD, FS.

The correct nozzle size ensures successful application

If the nozzle size is too small, there is an upper limit for the application quantity or possible speed. The PWM system can open by a maximum of 100% and then possibly increase the pressure. There is a risk of drift if the pressure exceeds the recommended pressure for the nozzle.

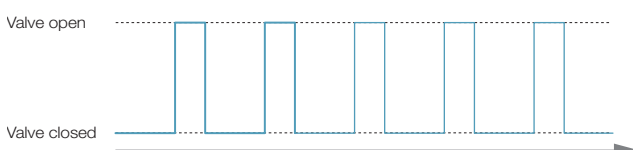

Duty cycle (DC) 30%:
The nozzle does not deliver any plant protection product for 70% of the time.

The PWM system can compensate for an excessively large nozzle size by means of a lower duty cycle of 50%–30%, for example, and a reduction in the pressure range. The risk of more uneven distribution of the liquid in longitudinal and lateral direction as well as lower wetting due to the coarser droplet spectrum must be taken into account. The distribution may not be optimal particularly at higher speeds above 10 km/h and with a duty factor of less than 40%.

		DC PWM		[l/ha]							
		%	[l/min]	6.0 km/h	8.0 km/h	10.0 km/h	12.0 km/h	14.0 km/h	16.0 km/h	18.0 km/h	20.0 km/h
06	1	100	1.36	272	204	163	136	117	102	91	82
		70	0.95	190	143	114	95	82	71	63	57
		50	0.68	136	102	82	68	58	51	45	41
		30	0.41	82	61	49	41	35	31	27	24
	2	100	1.93	386	290	232	183	165	145	129	116
		70	1.35	270	203	162	135	116	101	90	81
		50	0.97	193	145	116	97	83	72	64	58
		30	0.58	116	87	69	58	50	43	39	35
	3	100	2.36	472	354	283	236	202	177	157	142
		70	1.65	330	248	198	165	142	124	110	99
		50	1.18	236	177	142	118	101	89	79	71
		30	0.71	142	106	85	71	61	53	47	42
	4	100	2.73	546	410	328	273	234	205	182	164
		70	1.91	382	287	229	191	164	143	127	115
		50	1.37	273	205	164	137	117	102	91	82
		30	0.82	164	123	98	82	70	61	55	49
	5	100	3.05	610	458	366	305	261	229	203	183
		70	2.14	427	320	256	214	183	160	142	128
		50	1.53	305	229	183	153	131	114	102	92
		30	0.92	183	137	110	92	78	69	61	55
	6	100	3.34	668	501	401	334	286	251	223	200
		70	2.34	468	351	281	234	200	175	156	140
		50	1.67	334	251	200	167	143	125	111	100
		30	1	200	150	120	100	86	75	67	60
	8	100	3.86	772	579	463	386	331	290	257	232
		70	2.7	540	405	324	270	232	203	180	162
		50	1.93	386	290	232	193	165	145	129	116
		30	1.16	232	174	139	116	99	87	77	69

Based on the example of the above table for nozzle size 06 it is possible to clearly see the relationship between sprayer speed and duty cycle.

Determination of nozzle size

The flow rate control range of a nozzle is significantly increased with PWM. Selection of the correct nozzle size therefore requires a different approach. Ideally, the nozzle size is determined for a duty cycle of 70% and average sprayer speed.

With a constant pressure in the boom, this allows the flow rate of a nozzle to be increased or reduced by 30% respectively – in the range from 100% to 40%.

Rule of thumb:

Nozzle size x 1.5 = nozzle size for PWM

If a nozzle of size 04 is used without PWM technology, size 06 would be the recommended nozzle size with PWM technology with otherwise unchanged application conditions. The recommended pressure ranges of the nozzle series also apply for PWM.

Good to know

You can find lists of the PWM nozzles that have been included in the JKI "Directory of loss-reducing equipment" on our website.



Current list at:
www.lechler.com/de-en/service/loss-reducing

➤➤ APPLICATIONS AT A GLANCE

Efficient in every environment. There is a guiding principle that can be found in all agricultural technology products from Lechler:

We want to help

- to achieve the best result
- in the shortest time
- with the minimum product consumption.

No matter whether for environmentally-friendly application of plant protection products, demand-oriented liquid fertilizer delivery in crop production, uniform and controlled atomization in ground care or fast and thorough tank cleaning: We are ready for every challenge.

CROP PRODUCTION

Arable crops

- Plant protection
- Liquid fertilizer delivery

Bush and tree crops

- Plant protection

Horticulture

- Plant protection
- Liquid fertilizer delivery
- Irrigation

GROUND CARE

Golf courses/sports grounds

- Plant protection
- Liquid fertilizer delivery
- Irrigation

Traffic areas/airports

- De-icing
- Dust suppression

Riding arena floors

- Sprinkling

TANK CLEANING

- Cleaning
- Mixing
- Induction





➤ CROP PRODUCTION

When it comes to sustainable crop production, it is nowadays necessary to observe and compare a very wide range of differing requirements: international guidelines, national regulations, biological effectiveness, ecology, economy ...

In addition to these requirements, efficient application of all plant protection products and liquid fertilizer delivery that is gentle on the plants must naturally be guaranteed. At Lechler, we focus all our attention on combining these requirements in the optimum nozzle for your purposes.

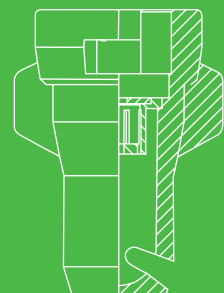
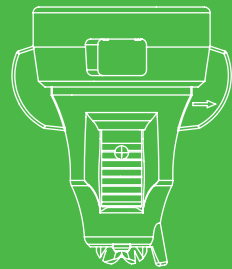

➤ NOZZLES FOR CROP PRODUCTION



TECHNICAL REQUIREMENTS

Optimum application of plant protection products is guaranteed only if narrow flow rate tolerances and uniform distribution are ensured. These parameters are laid down in the JKI and ENTAM guidelines and in the corresponding EN/ISO standards on European and international level.

In the case of JKI-approved Lechler nozzles, the volume flow of new nozzles may deviate from the table value by a maximum of $\pm 5\%$. This applies to spraying both field crops as well as bush and tree crops.



In combination, new JKI-recognized Lechler nozzles must guarantee the most uniform cross distribution possible. The coefficient of variation over the entire width of the spray boom must not exceed 7% in the specified pressure range and with the corresponding spray heights.

BIOLOGICAL REQUIREMENTS

In order to achieve the optimum effect, application of plant protection products must be extremely precise. Lechler precision nozzles achieve exact dosage and uniform distribution. Independently of this, the recommendations of the plant protection product manufacturers with respect to l/ha quantities must always be observed. Determination of the application area before use is of decisive importance for optimum deposition of the plant protection product.

Delivery takes place via flat fan and double flat fan nozzles. Flat fan nozzles generally achieve good crop penetration (e.g. mildew control in cereal crops). In contrast, double flat fan nozzles are recommended for optimum deposition on vertical target surfaces (e.g. grass control, ear treatment) and to reduce spray shadow (e.g. direct seed, cloddy soil).



ENVIRONMENTALLY-RELEVANT REQUIREMENTS

The wind and thermal currents can cause some of the droplets containing the active ingredients to miss the target area. This drift can pollute or damage adjacent crops, contaminate nearby waters and pose a risk to both humans and animals. In addition, drift frequently leads to incorrect dosages for the crop being treated.

The causes of drift depend on equipment-specific and meteorological factors such as:

- Droplet size
- Sprayer velocity
- Spray height
- Wind speed
- Air temperature
- Air humidity

LOSS-REDUCING EQUIPMENT

Application regulations for plant protection products, e.g. distance restrictions to water and field boundary structures, have been defined in order to protect non-target organisms. Depending on the toxicity of the plant protection product, the distances from water and field boundaries can be reduced with loss-reducing equipment, e.g. with air injector nozzles.

Lechler nozzles are officially approved in many European countries as drift-reducing devices in the drift reduction classes 99/95/90/75/66/50 and 25 %. The criteria on which the distance regulations are based in the individual countries comprise, among other things, the nozzle technology, water type, bank vegetation, width of the field boundary, mixture concentration, process technology (e.g. pressure) as well as external influences such as wind direction, wind speed and temperature.

Drift-reducing Lechler nozzles allow areas to be used more efficiently while at the same time protecting field boundaries and water.



Nozzle recommendations for plant protection/herbicide applications

Cereal crops

Crop protection applications

Two-nozzle strategy

- ID, IDK/IDKN: good crop penetration
- XDT, IDTA, IDKT: optimum deposition without spray shadow

Herbicide (BBCH 00-31): XDT 3.0–8.0 bar, IDTA 4.0–8.0 bar, IDKT 1.5–3.0 bar

Fungicide/Insecticide (BBCH 31-92): IDTA 4.0–8.0 bar, IDK/IDKN 1.5–3.0 bar; ID 4.0–8.0 bar, IDK/IDKN 1.5–3.0 bar; IDTA 4.0–8.0 bar, IDKT 1.5–3.0 bar

Further recommendations (BBCH 61-92): IDTA 4.0–8.0 bar, IDKT 1.5–3.0 bar

BBCH development stage: 00, 07, 09, 13, 21, 25, 29, 30, 31, 32, 37, 39, 49, 51, 59, 61–69, 71–92

Copyright © 2018 Lechler GmbH. All rights reserved.

Rape seed

Crop protection applications

Herbicide (BBCH 00-18): PRE 1.5 – 8.0 bar; XDT 3.0–8.0 bar

Fungicide/Insecticide (BBCH 18-79): IDTA 4.0–8.0 bar, IDKT 1.5–3.0 bar; ID 4.0–8.0 bar, IDK/IDKN 1.5–3.0 bar; Dropleg^{UL} TwinSprayCap FT 1.0–3.0 bar

Further recommendations (BBCH 61-79): Dropleg^{UL} TwinSprayCap FT 1.0–3.0 bar

BBCH development stage: 00, 10, 11, 12, 13, 14, 18, 33, 51, 55, 57–59, 61–65, 66–67, 69, 79

Copyright © 2018 Lechler GmbH. All rights reserved.

Sugar beet

Crop protection applications



Further recommendations



IDTA 4.0–8.0 bar
IDKT 1.5–3.0 bar



ID 4.0–8.0 bar
IDK/IDKN 1.5–3.0 bar

Insecticide



IDTA 4.0–8.0 bar
IDKT 1.5–3.0 bar

Herbicide



IDTA 4.0–8.0 bar
IDKT 1.5–3.0 bar

Fungicide

ID 4.0–8.0 bar
IDK/IDKN 1.5–3.0 bar

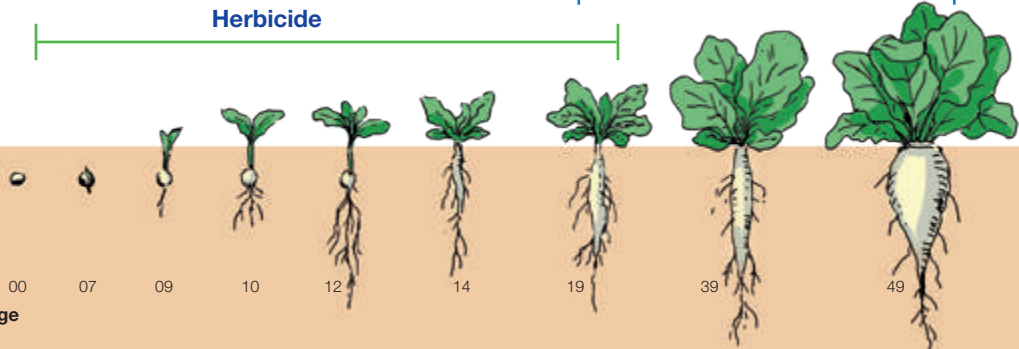

Copyright © 2018 Luchter GmbH. All rights reserved.

Corn

Herbicide applications



Further recommendations



Dropleg^{UL}
FT 1.0–3.0 bar

Herbicide



IDTA 4.0–8.0 bar
IDKT 1.5–3.0 bar

Herbicide

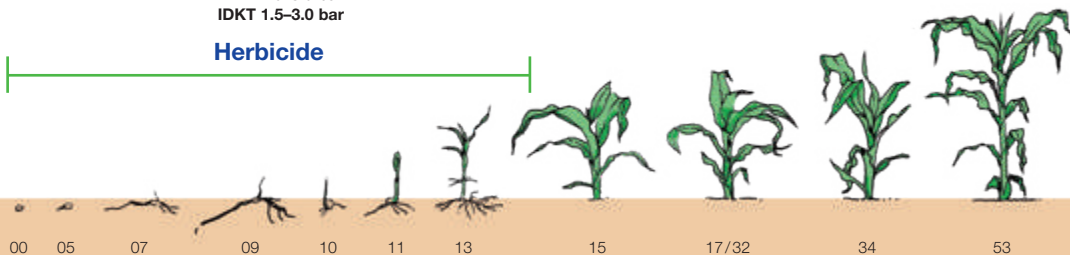

Copyright © 2018 Luchter GmbH. All rights reserved.



Nozzles for crop production

Overview

NEW

Series	ID	IDK/IDKN	IDTA	IDKT	PRE	AD	QS	LU	ST/SC	XDT	DF	FT
Spray angle	120/90	IDK 120/90 IDKN 120	120	120	130	120/90	80	120/90	ST 110/80 SC 110	130	120	140/90
Information on Page	46	48	62	64	50	52	56	54	58	60	66	70
Drift reduction	++	+	++	+	+++	o	o/-	o/-	-	+++	--	+(-)
Spray geometry												

Arable crops

Recommended pressure range [bar]		2/3* 4-8	1**/1.5-3-6	1-4-8	1***/1.5-3-6	1.5-8	1.5-3-6	1.5-5	1.5-2.5-5	2-3-5	1.5-3-8	2-3-5	1-3-6(1-2-3)
Herbi- cides	Soil incorporated	●●	●●	●●	●●	●●	●●	●●	●●	●	●●		●●
	Pre-emergence	●●	●●	●●	●●	●●	●●	●●	●●	●	●●		●●
	Post-emergence (systemic)	●●	●●	●●	●●		●●	●●	●●	●	●●	○	●
	Post-emergence (contact)	●	●	●●	●●		●	●●	●●	●	●	●●	●
Fungi- cides	Contact	●	●	●●	●●		●	●●	●●	●		●●	●
	Systemic	●●	●●	●●	●●		●●	●●	●●	●		●	●
Insecti- cides	Contact	●	●	●●	●●		●	●●	●●	●		●●	●
	Systemic	●●	●●	●●	●●		●●	●●	●●	●		●	●
Liquid fertilizer		●●(2-4)	●●(1**/1.5-2.5)	○(1-4)	○(1**/1.5-2.5)	●●(1.5-4)	●(1.5-2.5)	○(1.5-2)	○(1.5-2)	○(2)			●(1-2)
Growth regulators		●●	●●	○	○		●●	●	●	●		○	●
Irrigation		●●	●●	●●	●●	●●	●●	●	●	●	●●		

Arable crops and specialty/row crops

Recommended pressure range [bar]													
Herbi- cides	Soil incorporated												
	Pre-emergence												
	Post-emergence (systemic)												
	Post-emergence (contact)												
Fungi- cides	Contact												
	Systemic												
Insecti- cides	Contact												
	Systemic												
Liquid fertilizer													
Growth regulators													
Irrigation													

Viticulture, orchard and specialty crops

Recommended pressure range [bar]									5-10-30			
Fungicides	Contact								●●			
	Systemic								●●			
Insecticides	Contact								●●			
	Systemic								●●			
Growth regulators									●●			

Observe specifications of product manufacturers.

Nozzle sizes: * ID-01/-015

** IDK 04/-05/-06/-08/-10
IDKN 03/-04

*** IDKT 03/-04/-05/-06/-08/-10

**** FS 10/-15

***** IDKS 03/-04/-05/-06

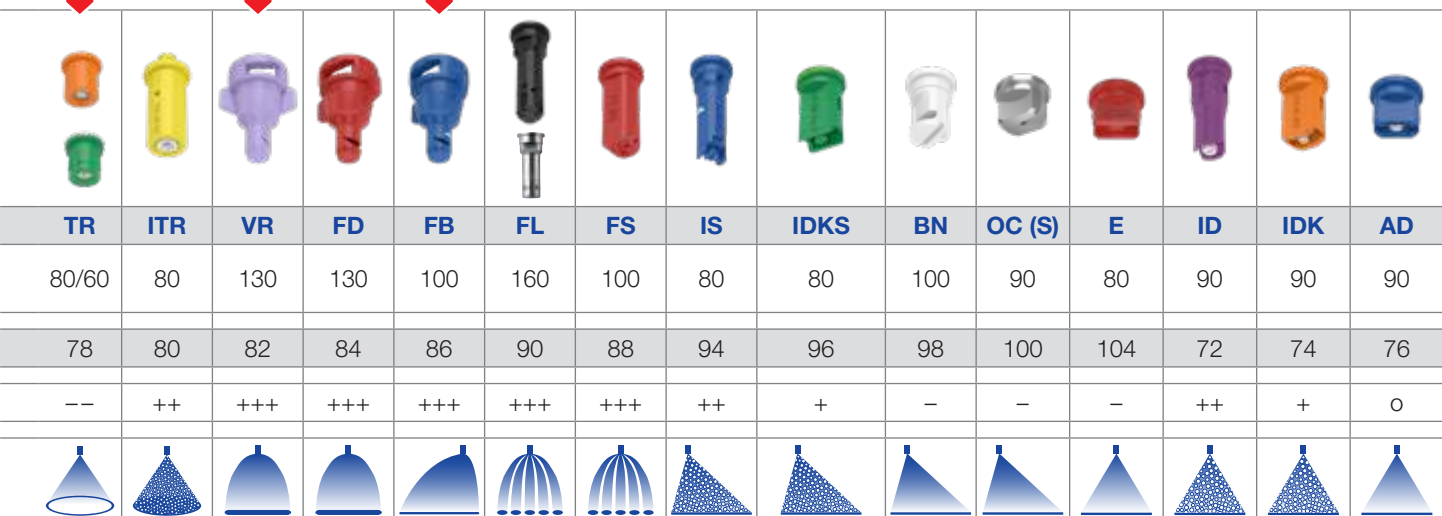

NEW**NEW****NEW**

TR	ITR	VR	FD	FB	FL	FS	IS	IDKS	BN	OC (S)	E	ID	IDK	AD
80/60	80	130	130	100	160	100	80	80	100	90	80	90	90	90
78	80	82	84	86	90	88	94	96	98	100	104	72	74	76
--	++	+++	+++	+++	+++	+++	++	+	-	-	-	++	+	0

3-8	3-5-10	2-8	1.5-4	1.5-4	1-5	1-3****/4	2-4-8	1*****/1.5-3-6	1.5-2.5-5	2-8	1.5-8	1.5-3-6
○	●●						●●	●●	●●	●●	●●	●●
○	○						●●	●●	●●	●●	●●	●●
○	○						●●	●●	●●	●●	●●	●●
●●							●	●	●●	●	●	●
●●	○						●	●	●●	●	●	●
●	●						●●	●●	●●	●●	●●	●●
●●	○						●	●	●●	●	●	●
●	●						●●	●●	●●	●●	●●	●●
	●●(3-5)	●●	●●	●●	●●	●●	●●(2-4)	●●(1*****/1.5-2.5)	○(1.5-2)	●●(2-4)	●●(1.5-2.5)	●●(1.5-2.5)
○	○						●●	●●	●	●●	●●	●●
	●	●●	●●	●●	●	●	●●	●●	●	●●	●●	●●

3-8	2-4-8	1*****/1.5-3-6	1-2-4-6	1.5-2.5-5	1-3-4
○	●●	●●	●●	●●	●●
○	●●	●●	●●	●●	●●
○	●●	●●	●●	●●	●●
●●	●	●	●●	●●	●●
●●	●	●	●●	●●	●●
●	●●	●●	●●	●●	●●
●●	●	●	●●	●●	●●
●	●●	●●	●●	●●	●●
	●●(2-4)	●●(1*****/1.5-2.5)	○(1-2)	○(1.5-2)	○(1-2)
○	●●	●●	●●	●●	●
	●●	●●	●●	●	●

3-8-20	10-30	2-8-15	1*****/1.5-8-15	2-8-15-20	2-8-15-20	2-8-15-20
●●	●	●●	●●	●●	●●	●●
●●	●●	●●	●●	●●	●●	●●
●●	●	●●	●●	●●	●●	●●
●●	●●	●●	●●	●●	●●	●●
●●	●	●●	●●	●●	●●	●●

-- = not drift-reducing - = slightly drift-reducing ○ = drift-reducing + = very drift-reducing ++ = highly drift-reducing +++ = extremely drift-reducing
 ●● = very well-suited ● = well-suited ○ = less well-suited



GROUND CARE

Lechler nozzles for ground care are used wherever it is necessary to uniformly spray large public or traffic areas, for example. Our wide product range offers a suitable solution for every application.

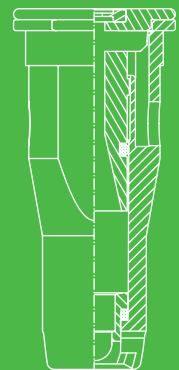
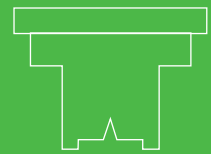
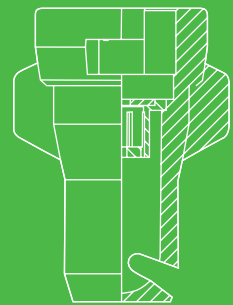
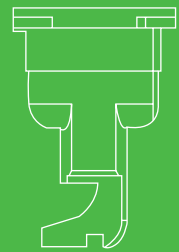

➤➤ NOZZLES FOR
GROUND CARE





EVERYTHING COVERED

Lechler offers a wide range of nozzles and accessories for ground care. Various designs are available that are matched to the task in hand, ranging from solid stream and hollow cone nozzles through to flat fan and wide-throw nozzles. The main selection criteria are economy, efficiency and user protection.

Alongside delivery of plant protection products and nutrients in green urban spaces, the other varied tasks include dust suppression, de-icing, hot-water treatment, etc.

THE ENTIRE RANGE OF GROUND CARE APPLICATIONS

Ground care includes all municipal green areas (e.g. parks) as well as traffic areas (e.g. railroad tracks, airports, roads), golf courses, sports grounds and riding arenas. The applications are therefore very different and varied. They extend from pest control through to dust suppression and surface de-icing. The equipment used covers a wide range – from simple back spraying through to high-tech systems for airport de-icing.

In view of the sometimes considerable amount of sprayed product, efficiency, durability and cost control are key factors for economic operation. With our wide, solution-oriented product range, we ensure that the best-suited nozzle is available for every task.

GOLF COURSES

Grass sport areas must be maintained in a functionally and environmentally appropriate way through low-drift application of plant protection products and biocides – e.g. using ID, IDK, IDTA, IDKT or also XDT nozzles. Gentle liquid fertilizer delivery to supply plants with nutrients is preferably performed using FD and VR nozzles.



WEED CONTROL

Spray trains are usually equipped with low-drift ID nozzles in the middle section and narrow-jet flood or off-center nozzles at the sides. This makes it possible to reliably keep the tracks free of undesired plant growth and at the same time focus product application in a narrow area.



VITICULTURE AND TREE/SHRUB PROTECTION

Low-drift nozzles such as IDK nozzles provide optimum protection for users when carrying out pest control measures on trees and shrubs.





Source: RAW Handel und Beratungs GmbH

DUST SUPPRESSION

ID and FD nozzles permit effective dust binding on traffic areas.



DE-ICING

De-icing of traffic areas (e.g. airports, roads) with saline solution is an effective and economical process. Here, low-drift ID nozzles are used in the center section in combination with VarioSelect for variable nozzle control in order to maintain a constant application quantity at changing driving speeds. Side widening up to an overall working width of 12 m is realized with solid stream nozzles.























SPRINKLING

Three nozzle rows equipped with the ID air injector nozzle ensure an optimally watered riding arena in combination with rake, tilling roller and smoothing attachment.





➤➤ Nozzles for ground care Overview

NEW

										
Series	ID	IDK/IDKN	IDTA	IDKT	PRE	AD	QS	LU	ST/SC	XDT
Spray angle	120/90	IDK 120/90 IDKN 120	120	120	130	120/90	80	120/90	110/80	130
Information on Page	46	48	62	64	50	52	56	54	58	60
Drift reduction	++	+	++	+	+++	o	o/-	o/-	-	+++
Spray geometry										
Recommended pressure range [bar]	2/3*-4-8	1**-/1.5-3-6	1-4-8	1***-/1.5-3-6	1.5-8	1.5-3-6	1.5-5	1.5-2.5-5	2-3-5	1.5-3-8
Herbicides	Soil incorporated	●●	●●	●●	●●	●●	●●	●●	●●	●●
	Pre-emergence	●●	●●	●●	●●	●●	●●	●●	●●	●●
	Post-emergence (systemic)	●●	●●	●●	●●	●●	●●	●●	●●	●●
	Post-emergence (contact)	●	●	●●	●●	●	●●	●●	●	●●
Fungicides	Contact	●	●	●●	●●	●	●●	●●	●	●●
	Systemic	●●	●●	●●	●●	●●	●●	●●	●	●●
Insecticides	Contact	●	●	●●	●●	●	●●	●●	●	●●
	Systemic	●●	●●	●●	●●	●●	●●	●●	●	●●
Liquid fertilizer	●●(2-4)	●●(1**/1.5-2.5)	○(1-4)	○(1***/1.5-2.5)	●●(1.5-4)	●(1.5-2.5)	○(1.5-2)	○(1.5-2)	○(2)	
Growth regulators	●●	●●	●	○		●●	●	●	●	
Irrigation, watering, dust suppression, de-icing of traffic areas	●●	●●	●●	●●	●●	●●	●	●	●	●●

Observe specifications of product manufacturers.

Hot-water treatment: Nozzles made of stainless steel, e.g. series 652.

															
	DF	FT	TR	ITR	VR	FD	FB	FL	FS	IS	IDKS	BN	OC (S)	E	OC (W)
	120	140/90	80/60	80	130	130	100	160	100	80	80	100	90	80	90
	66	70	78	80	82	84	86	90	88	94	96	98	100	104	102
	—	+(-)	—	++	+++	+++	+++	+++	+++	++	+	—	—	—	—
															
	2-3-5	1-3-6 (1-2-3)	3-8	3-5-10	2-8	1.5-4	1.5-4	1-5	1-3****/4	2-4-8	1****/1.5-3-6	1-2-4-6	1.5-2.5-5	1-3-4	2-5
		●●	○	●●						●●	●●	●●	●●	●●	●
		●●	○	○						●●	●●	●●	●●	●●	●●
	○	●	○	○						●●	●●	●●	●●	●●	●●
	●●	●	●●							●	●	●●	●●	●●	●●
	●●	●	●	○						●●	●●	●●	●●	●●	●●
	●●	●	●●	○						●	●	●●	●●	●●	●●
	●	●	●	●						●●	●●	●●	●●	●●	●●
		●(1-2)		●●(3-5)	●●	●●	●●	●●(1-5)	●●(1-5)	●●(2-4)	●●(1****/1.5-2.5)	○(1-2)	○(1.5-2)	○(1-2)	○(2)
	○	●	●	○						●●	●●	●●	●●	●	●
				●	●●	●●	●●	●	●	●●	●●	●●	●	●	●●

Nozzle sizes: * ID-01/-015 ** IDK 04/-05/-06/-08/-10 *** IDKT 03/-04/-05/-06/-08/-10 **** FS 10/-15 ***** IDKS 03/-04/-05/-06
IDKN 03/-04

-- = not drift-reducing - = slightly drift-reducing ○ = drift-reducing + = very drift-reducing ++ = highly drift-reducing +++ = extremely drift-reducing
●● = very well-suited ● = well-suited ○ = less well-suited





CLEANING, AGITATING AND RINSING

Lechler offers a unique product range for every tank application in agriculture, animal husbandry and wineries.

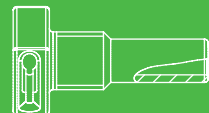
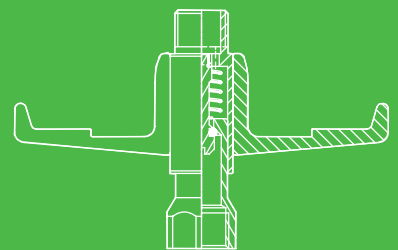

 NOZZLES FOR
CONTAINERS AND TANKS





WIDE RANGE, SHARP FOCUS









Efficiency has the highest priority when it comes to container and tank cleaning. Because only fast and thorough cleaning removes all residues. The Lechler nozzle range offers innovative nozzle technologies as well as a large selection of sizes and materials for cleaning and flushing containers, tanks and induction hoppers.

In addition, special nozzles facilitate homogenization of tank contents.

The multiple award-winning nozzles of the Cleaner series are available especially for plant protection equipment. All nozzles in our range and the accessories are matched to each other. The ISO color coding makes it easier to always choose the right nozzle and prevents unnecessary application errors.

➤➤ Nozzles for cleaning, agitating and rinsing









Overview

				
Series	WallCleaner	CanCleaner	ContiCleaner	Static spray balls 540/541
Information on Page	107	114	113	112
Spray geometry				
Cleaning of containers and tanks			●●	●●
Internal cleaning of induction hoppers	●●	●	○	●
Cleaning of canisters		●●		●
Continuous internal cleaning			●●	
Function, max. cleanable tank diameter	Induction and cleaning of side walls	Cleaning, max. 1.3 m	Cleaning, max. 1.6 m	Rinsing, max. 7.5 m
Features	Cleaning without dead zones	Increased flow rate to canister bottom	Reliable start-up at low pressure	High operating reliability

Nozzle selection

The choice of the right Lechler rotating cleaning nozzle or a suitable static spray ball is determined primarily by the type of dirt to be cleaned and the tank diameter.

Simple rinsing with static spray balls is often sufficient for non-adhering substances. However, the higher the level of soiling and the more stubborn the dirt, the more important the jet force of the nozzle. In such cases, cleaning with rotating cleaning nozzles is recommended. It must be ensured that the diameter of the tank to be cleaned is smaller than the maximum possible tank diameter specified for the nozzle.

			
MicroWhirly 500/566	MiniWhirly 500.186	MiniSpinner 2 5M3	Injector agitator nozzles
113	114	115	106
			
●●	●	●●	●●
●	●		
●	●		
●	●		
Cleaning, max. 1.6 m	Cleaning, max. 1.3 m	Cleaning, max. 2.3 m	Mixing, rinsing of liquids
Easy start-up thanks to slide bearings	Ball-bearing mounted	Efficient cleaning of large tanks	Efficient mixing, rinsing with rotating arrangement

●● = very well-suited ● = well-suited
○ = less well-suited

Nozzles for cleaning and rinsing



Static

Static spray balls are inexpensive to purchase and offer a trouble-free solution for rinsing tanks. However, they require considerably higher fluid quantities because they do not rotate.



Free-spinning

The cleaning fluid drives the spray head by means of specially aligned nozzles. The rapidly repeated impacts detach the dirt and rinse it from the tank surface. This results in optimum cleaning efficiency at low pressures in small to medium-sized tanks.



Spray balls

Rotating cleaners

➤ Container and tank cleaning

Principles and characteristics



Nozzle positioning

The cleaning nozzles should be positioned in the upper part of the tank if possible. It must be ensured that sufficient cleaning fluid strikes the tank ceiling.

When cleaning large tanks, it may be necessary to install several nozzles. The nozzles should then be positioned so that their spray jets overlap. The spray jet can then reach almost every surface to be cleaned.

Avoidance of spray shadows

Surge plates, agitators or lines prevent the locations behind them from being impacted directly by the spray jet of a tank cleaning nozzle. Cleaning by direct impact is not possible in these locations.

For this reason, several nozzles must be used in tanks and containers with built-in equipment. The number of nozzles should be chosen so that the spray shadows of the individual nozzles are eliminated.

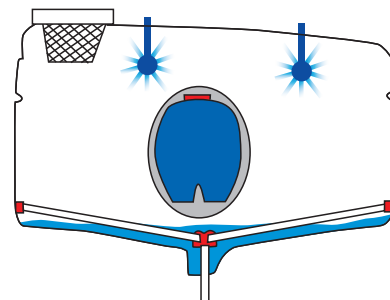

Exterior cleaning of plant protection equipment

Ideally, the exterior of sprayers is also cleaned after the end of product application. Exterior cleaning takes place on the treated area or another vegetated area.

Modern sprayers are equipped with a low- or high-pressure cleaning gun or lance for exterior cleaning of the tank, boom, nozzles, support frame and other components. Efficient and water-saving cleaning is possible with narrow-jet high-pressure cleaning nozzles.



➤ Application examples Plant protection equipment



Nozzles for continuous internal cleaning

In the case of continuous internal cleaning, the tank cleaning nozzles are selected corresponding to the number of nozzles on the equipment and depending on the nozzle size. To ensure efficient cleaning, the flow rate of the cleaning nozzles must not exceed 90% of the total nozzle output (all nozzles on the equipment).

For example, a field spray with 15 m boom and with 30 IDKN 120-03 nozzles and a cleaning pressure of 2 bar produces a total nozzle output of 29.1 l/min. In this example, the cleaning nozzles for continuous internal cleaning may have a delivery of max. 26.2 l/min. This requirement is met by equipping the tank with two ContiCleaner 30 nozzles (each 9.8 l/min at 2 bar). This ensures that no diluted spray mixture residue builds up in the tank and that cleaning can take place continuously.

The required number of inner cleaning nozzles depends on the shape of the spray tank, the surge plates as well as other built-in components in the tank. It is essential to make sure that all areas of the spray tank are reached and that there are no blind spots. The ContiCleaner has been designed especially for this application. Several nozzle sizes with ISO color coding are available. This nozzle already starts up easily at low pressure with reduced flow rate.

Nozzles for agitation and homogenization

After the plant protection product is flushed into the tank of the plant protection equipment, Lechler injector agitator nozzles ensure fast and homogeneous mixing of the spray mixture. The injector effect of the nozzle reinforces the turbulence of the solid jet. As a result, a large volume in the tank can be circulated in a short time with a low volume flow.

Several injector agitator nozzles with a lower volume flow produce a more intensive agitation effect than a single, large agitator nozzle. In particular, corners and suction sumps are reached more effectively. Dead zones are avoided.

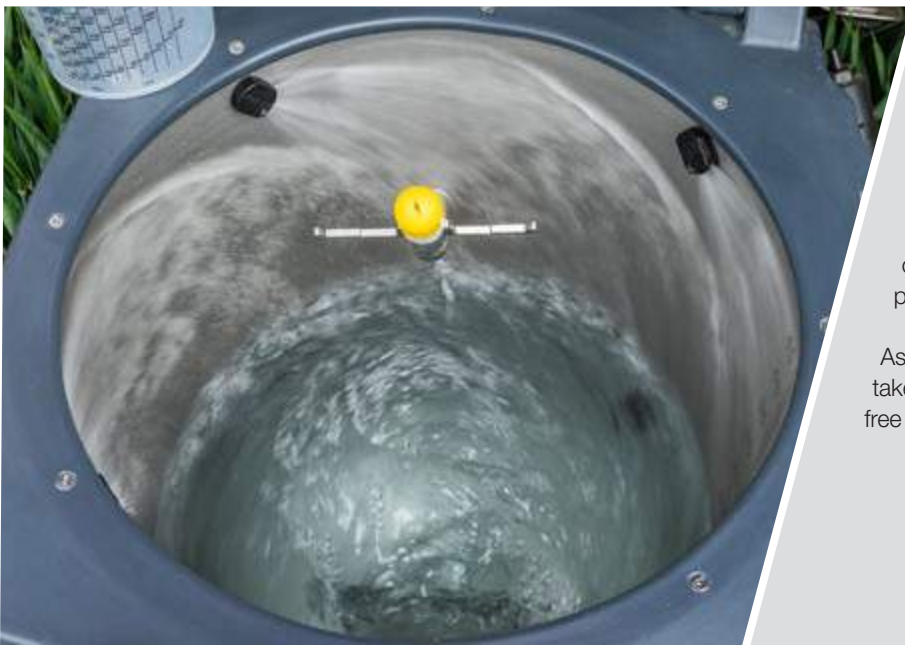

Nozzles for induction hoppers

Lechler offers special, user-friendly nozzle technology for induction hoppers: the WallCleaner. This leads to improved user protection and effectively prevents residues. The induction hopper nozzles clean the wall surfaces of the induction hopper completely up to under the edge.

As a result of the rotating liquid flow, premixing already takes place during induction and therefore ensures lump-free induction of powder plant protection products.



NOZZLES OUR AGRICULTURAL RANGE IN DETAIL

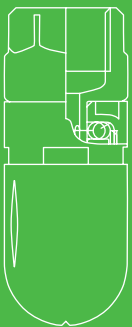
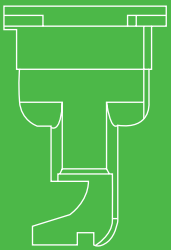



Air-injector flat spray nozzles

ID-120/ID-90

ID3

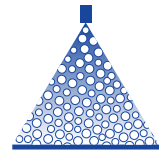

Crop production / Ground care

- Air-aspirating flat spray nozzle
- Extremely low-drift

Advantages

- 90 % drift reduction for: ID-120-025 to -06
- Drift stability over a large pressure range thanks to long injector design
- Timely application even under adverse weather conditions
- Increased workrate due to flexible use over a wide pressure range – adaptation by changing the sprayer speed and l/ha rate without nozzle changes
- Very good deposition structure and crop penetration
- Suitable for PWM



ID

ID-C

Series ID



Injector can be removed without tools

Dimensions in mm.

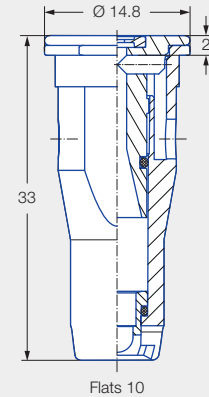

Flats 10

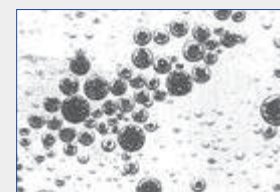
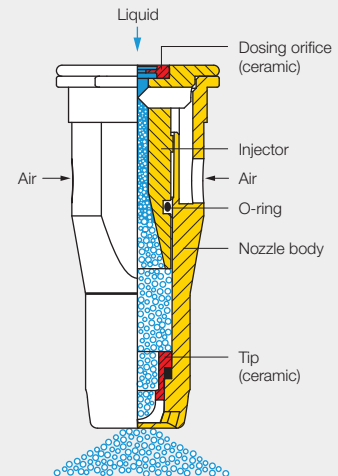

Bubble formation



JKI approval as loss-reducing: 90/75/50 %

G 1965, G 1966, G 1968, G 1969, G 1970, G 1971, G 1972, G 1973, G 1974, G 2088

JKI approval for mixed equipment and border nozzle IS.



Current list at: www.lechler.com/de-en/service/loss-reducing

Application:



Plant protection products and growth regulators



Liquid fertilizer delivery



Edge application
Can be combined with border nozzle IS 80



Golf course

Technical data:



Nozzle sizes
01–10



Spray angles
90°, 120°



Materials
POM, ceramic



Pressure ranges

- ID-01 to -015: 3–4–8 bar
- ID-02 to -10: 2–4–8 bar
- UAN: 2–4 bar



Recommended strainers

- 80 M 01
- 60 M 015-04
- 25 M 05–10



Droplet sizes
Ultra coarse – medium



Width across flats
10 mm

	ISO 25358	[l/min]	[l/ha]									
			5.0 km/h	6.0 km/h	7.0 km/h	8.0 km/h	10.0 km/h	12.0 km/h	14.0 km/h	16.0 km/h	18.0 km/h	
ID-120-01 90-01 (80 M)	EC	3.0	0.39	94	78	67	59	47	39	33	29	26
	VC	4.0	0.45	108	90	77	68	54	45	39	34	30
	VC	5.0	0.51	122	102	87	77	61	51	44	38	34
	VC	6.0	0.55	132	110	94	83	66	55	47	41	37
	C	7.0	0.60	144	120	103	90	72	60	51	45	40
	C	8.0	0.64	154	128	110	96	77	64	55	48	43
ID-120-015 90-015 (60 M)	VC	3.0	0.59	142	118	101	89	71	59	51	44	39
	VC	4.0	0.68	163	136	117	102	82	68	58	51	45
	VC	5.0	0.76	182	152	130	114	91	76	65	57	51
	C	6.0	0.83	199	166	142	125	100	83	71	62	55
	C	7.0	0.90	216	180	154	135	108	90	77	68	60
	C	8.0	0.96	230	192	165	144	115	96	82	72	64
ID-120-02 90-02 (60 M)	EC	2.0	0.65	156	130	111	98	78	65	56	49	43
	VC	3.0	0.80	192	160	137	120	96	80	69	60	53
	VC	4.0	0.92	221	184	158	138	110	92	79	69	61
	VC	5.0	1.03	247	206	177	155	124	103	88	77	69
	C	6.0	1.13	271	226	194	170	136	113	97	85	75
	C	7.0	1.22	293	244	209	183	146	122	105	92	81
	M	8.0	1.30	312	260	223	195	156	130	111	98	87
ID-120-025 90-025 (60 M)	UC	2.0	0.81	194	162	139	122	97	81	69	61	54
	EC	3.0	0.99	238	198	170	149	119	99	85	74	66
	VC	4.0	1.15	276	230	197	173	138	115	99	86	77
	VC	5.0	1.28	307	256	219	192	154	128	110	96	85
	VC	6.0	1.40	336	280	240	210	168	140	120	105	93
	VC	7.0	1.52	365	304	261	228	182	152	130	114	101
	VC	8.0	1.62	389	324	278	243	194	162	139	122	108
ID-120-03 90-03 (60 M)	UC	2.0	0.97	233	194	166	146	116	97	83	73	65
	EC	3.0	1.19	286	238	204	179	143	119	102	89	79
	VC	4.0	1.37	329	274	235	206	164	137	117	103	91
	VC	5.0	1.53	367	306	262	230	184	153	131	115	102
	VC	6.0	1.68	403	336	288	252	202	168	144	126	112
	VC	7.0	1.81	434	362	310	272	217	181	155	136	121
	VC	8.0	1.94	466	388	333	291	233	194	166	146	129
ID-120-04 90-04 (60 M)	EC	2.0	1.29	310	258	221	194	155	129	111	97	86
	EC	3.0	1.58	379	316	271	237	190	158	135	119	105
	VC	4.0	1.82	437	364	312	273	218	182	156	137	121
	VC	5.0	2.04	490	408	350	306	245	204	175	153	136
	VC	6.0	2.23	535	446	382	335	268	223	191	167	149
	VC	7.0	2.41	578	482	413	362	289	241	207	181	161
	VC	8.0	2.58	619	516	442	387	310	258	221	194	172
ID-120-05 90-05 (25 M)	UC	2.0	1.61	386	322	276	242	193	161	138	121	107
	EC	3.0	1.97	473	394	338	296	236	197	169	148	131
	VC	4.0	2.28	547	456	391	342	274	228	195	171	152
	VC	5.0	2.55	612	510	437	383	306	255	219	191	170
	VC	6.0	2.79	670	558	478	419	335	279	239	209	186
	VC	7.0	3.01	722	602	516	452	361	301	258	226	201
	VC	8.0	3.22	773	644	552	483	386	322	276	242	215
ID-120-06 90-06 (25 M)	EC	2.0	1.93	463	386	331	290	232	193	165	145	129
	EC	3.0	2.36	566	472	405	354	283	236	202	177	157
	VC	4.0	2.73	655	546	468	410	328	273	234	205	182
	VC	5.0	3.05	732	610	523	458	366	305	261	229	203
	VC	6.0	3.34	802	668	573	501	401	334	286	251	223
	VC	7.0	3.61	866	722	619	542	433	361	309	271	241
	VC	8.0	3.86	926	772	662	579	463	386	331	290	257
ID-120-08 (25 M)	EC	2.0	2.58	619	516	442	387	310	258	221	194	172
	EC	3.0	3.16	758	632	542	474	379	316	271	237	211
	VC	4.0	3.65	876	730	626	548	438	365	313	274	243
	VC	5.0	4.08	979	816	699	612	490	408	350	306	272
	VC	6.0	4.47	1,073	894	766	671	536	447	383	335	298
	VC	7.0	4.83	1,159	966	828	725	580	483	414	362	322
	VC	8.0	5.16	1,238	1,032	885	774	619	516	442	387	344
ID-120-10 (25 M)	UC	2.0	3.22	773	644	552	483	386	322	276	242	215
	EC	3.0	3.94	946	788	675	591	473	394	338	296	263
	EC	4.0	4.55	1,092	910	780	683	546	455	390	341	303
	VC	5.0	5.09	1,222	1,018	873	764	611	509	436	382	339
	VC	6.0	5.57	1,337	1,114	955	836	668	557	477	418	371
	VC	7.0	6.02	1,445	1,204	1,032	903	722	602	516	452	401
	VC	8.0	6.43	1,543	1,286	1,102	965	772	643	551	482	429

ISO 25358 classification according to droplet sizes:

VF	Very fine
F	Fine
M	Medium
C	Coarse
VC	Very coarse
EC	Extremely coarse
UC	Ultra coarse

Subject to modifications.

- Operating pressure at the nozzle (measured with diaphragm valve)
- The stated liter-per-hectare rates apply to water
- Verify the table values by gauging the flow rates prior to every spraying season
- Pay attention to uniform nozzle adjustment

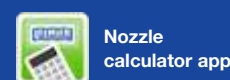

The apps for Lechler agricultural nozzles make selection and use of the optimum nozzle even easier. Find out more here: www.lechler.com/de-en/service/apps



Ordering example:	Series	+ Spray angle	+ Nozzle size	+ Material	= Order No.
	ID	+ 120°	+ 025	+ (POM)	= ID-120-025
	ID	+ 120°	+ 025	+ C (ceramic)	= ID-120-025 C



Compact air-injector flat spray nozzles

IDK 120/IDK 90 / IDKN 120

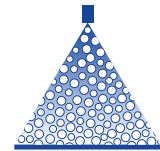

Crop production

Ground care

- Air-aspirating flat spray nozzle
- Very low drift

Advantages

- 95 % drift reduction for: IDK 90-015 C and -02 C with 25 cm nozzle spacing
- 90 % drift reduction for:
 - IDK 120-025 to -06
 - IDKN 120-03 to -04
- Compact design
- Large droplet size range from ultra coarse to medium
- Very low drift and loss-reducing in the pressure range up to 3.0 bar (depending on size)
- Inexpensive alternative to conventional standard nozzles
- Very good deposition structure and crop penetration
- Suitable for PWM



IDK



IDK-C



IDKN

IDKN characteristic:
Nozzle body with white stripe

Dimensions in mm.

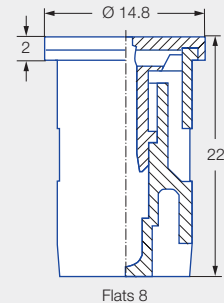

Series IDK/IDKN



Injector can be removed without tools

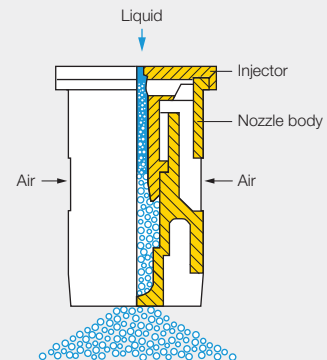

JKI approval as loss-reducing:
90/75/50 %

G 1661, G 1662, G 1663, G 1683, G 1718, G 1799, G 1800, G 1801, G 1802, G 1936, G 2052, G 2053

JKI approval for mixed equipment and border nozzle IDKS.



Current list at:
www.lechler.com/de-en/service/loss-reducing

Application:

Plant protection products and growth regulators

Liquid fertilizer delivery

Spray frame

Edge application
Can be combined with border nozzle IDKS 80

Golf course

Backpack sprayer

Greenhouse

Technical data:

Nozzle sizes
01–10

Spray angles
90°, 120°

Materials
POM, ceramic

Pressure ranges



- IDK 01 to -10: 1–1.5–3–6 bar
- IDKN 03 to -04: 1–1.5–3–6 bar
- UAN: 1.0–2.5 bar

Recommended strainers

- 80 M 01
- 60 M 015–04
- 25 M 05–10

Droplet sizes
Ultra coarse – medium

Width across flats
8 mm

	ISO 25358 		[l/min]	[l/ha] 											
				IDKN	IDK	5.0	6.0	7.0	8.0	10.0	12.0	14.0	16.0	18.0	
						km/h	km/h	km/h	km/h	km/h	km/h	km/h	km/h	km/h	km/h
IDK 120-01 90-01 (80 M)			EC	1.0	0.23	55	46	39	35	28	23	20	17	15	
			VC	1.5	0.28	67	56	48	42	34	28	24	21	19	
			VC	2.0	0.32	77	64	55	48	38	32	27	24	21	
			VC	3.0	0.39	94	78	67	59	47	39	33	29	26	
			C	4.0	0.45	108	90	77	68	54	45	39	34	30	
			M	6.0	0.55	132	110	94	83	66	55	47	41	37	
IDK 120-015 90-015 (60 M)			EC	1.0	0.34	82	68	58	51	41	34	29	26	23	
			VC	1.5	0.42	101	84	72	63	50	42	36	32	28	
			VC	2.0	0.48	115	96	82	72	58	48	41	36	32	
			C	3.0	0.59	142	118	101	89	71	59	51	44	39	
			C	4.0	0.68	163	136	117	102	82	68	58	51	45	
			M	6.0	0.83	199	166	142	125	100	83	71	62	55	
IDK 120-02 90-02 (60 M)			EC	1.0	0.46	110	92	79	69	55	46	39	35	31	
			VC	1.5	0.56	134	112	96	84	67	56	48	42	37	
			VC	2.0	0.65	156	130	111	98	78	65	56	49	43	
			VC	3.0	0.80	192	160	137	120	96	80	69	60	53	
			C	4.0	0.92	221	184	158	138	110	92	79	69	61	
			M	6.0	1.13	271	226	194	170	136	113	97	85	75	
IDK 120-025 90-025 (60 M)			EC	1.0	0.57	137	114	98	86	68	57	49	43	38	
			VC	1.5	0.70	168	140	120	105	84	70	60	53	47	
			VC	2.0	0.81	194	162	139	122	97	81	69	61	54	
			C	3.0	0.99	238	198	170	149	119	99	85	74	66	
			C	4.0	1.15	276	230	197	173	138	115	99	86	77	
			M	6.0	1.40	336	280	240	210	168	140	120	105	93	
IDK 120-03 90-03 IDKN 120-03 (60 M)			UC	EC	1.0	0.69	166	138	118	104	83	69	59	52	46
			EC	VC	1.5	0.84	202	168	144	126	101	84	72	63	56
			EC	VC	2.0	0.97	233	194	166	146	116	97	83	73	65
			VC	VC	3.0	1.19	286	238	204	179	143	119	102	89	79
			VC	C	4.0	1.37	329	274	235	206	164	137	117	103	91
			C	M	6.0	1.68	403	336	288	252	202	168	144	126	112
IDK 120-04 90-04 IDKN 120-04 (60 M)			UC	EC	1.0	0.91	218	182	156	137	109	91	78	68	61
			EC	EC	1.5	1.12	269	224	192	168	134	112	96	84	75
			EC	EC	2.0	1.29	310	258	221	194	155	129	111	97	86
			VC	VC	3.0	1.58	379	316	271	237	190	158	135	119	105
			VC	C	4.0	1.82	437	364	312	273	218	182	156	137	121
			C	C	6.0	2.23	535	446	382	335	268	223	191	167	149
IDK 120-05 90-05 (25 M)			EC	1.0	1.14	274	228	195	171	137	114	98	86	76	
			EC	1.5	1.39	334	278	238	209	167	139	119	104	93	
			VC	2.0	1.61	386	322	276	242	193	161	138	121	107	
			VC	3.0	1.97	473	394	338	296	236	197	169	148	131	
			VC	4.0	2.28	547	456	391	342	274	228	195	171	152	
			C	5.0	2.55	612	510	437	383	306	255	219	191	170	
IDK 120-06 90-06 (25 M)			EC	1.0	1.36	326	272	233	204	163	136	117	102	91	
			VC	1.5	1.67	401	334	286	251	200	167	143	125	111	
			VC	2.0	1.93	463	386	331	290	232	193	165	145	129	
			VC	3.0	2.36	566	472	405	354	283	236	202	177	157	
			C	4.0	2.73	655	546	468	410	328	273	234	205	182	
			C	6.0	3.34	802	668	573	501	401	334	286	251	223	
IDK 120-08 (25 M)			EC	1.0	1.82	437	364	312	273	218	182	156	137	121	
			EC	1.5	2.23	535	446	382	335	268	223	191	167	149	
			VC	2.0	2.58	619	516	442	387	310	258	221	194	172	
			VC	3.0	3.16	758	632	542	474	379	316	271	237	211	
			VC	4.0	3.65	876	730	626	548	438	365	313	274	243	
			C	6.0	3.34	802	668	573	501	401	334	286	251	223	
IDK 120-10 (25 M)			UC	1.0	2.27	545	454	389	341	272	227	195	170	151	
			EC	1.5	2.79	670	558	478	419	335	279	239	209	186	
			EC	2.0	3.22	773	644	552	483	386	322	276	242	215	
			VC	3.0	3.94	946	788	675	591	473	394	338	296	263	
			VC	4.0	4.55	1,092	910	780	683	546	455	390	341	303	
			C	6.0	5.57	1,337	1,114	955	836	668	557	477	418	371	

ISO 25358 classification according to droplet sizes:

VF	Very fine
F	Fine
M	Medium
C	Coarse
VC	Very coarse
EC	Extremely coarse
UC	Ultra coarse

Subject to modifications.

- Operating pressure at the nozzle (measured with diaphragm valve)
- The stated liter-per-hectare rates apply to water
- Verify the table values by gauging the flow rates prior to every spraying season
- Pay attention to uniform nozzle adjustment



Recommendation

Optimum protection of IDK/IDKN nozzles thanks to long design of MultiCap (see Page 124).

Available fully assembled with IDK and IDKN nozzles.



Nozzle calculator app

The apps for Lechler agricultural nozzles make selection and use of the optimum nozzle even easier. Find out more here: www.lechler.com/de-en/service/apps



Ordering	Series	+ Spray angle	+ Nozzle size	+ Material	= Order No.
example:	IDK	+ 120°	+ 01	+ (POM)	= IDK 120-01
	IDK	+ 120°	+ 01	+ C (Ceramic)	= IDK 120-01 C
	MultiCap IDK	+ 120°	+ 01	+ (POM)	= MultiCap IDK 120-01

Pre-emergence flat spray nozzle PRE



Crop production / Ground care

- Extremely low-drift flat spray nozzle
- For timely application of pre-emergence herbicides

Advantages

- 95 % drift reduction from 1.5 to 5 bar
- Flexible implementation of distance to water requirements
- Wide pressure range from 1.5–8 bar
- High workrate through simple adaptation of l/ha rate and driving speed
- Timely application even under adverse weather conditions
- Nozzle in cap with MULTIJET bayonet system (incl. gasket)
- Suitable for PWM

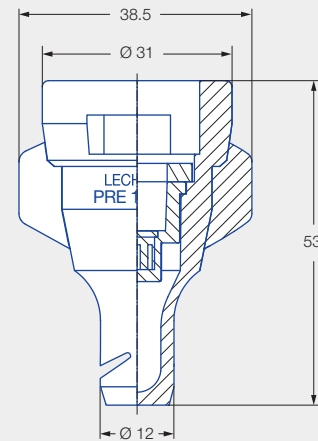

Dimensions in mm.

Series PRE



Pre-chamber can be removed without tools

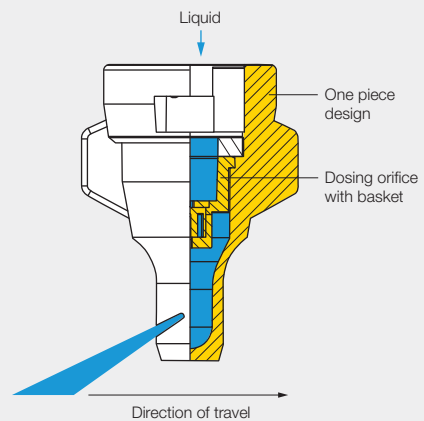

JKI approval as loss-reducing: 95/90 %

G 1981



Current list at: www.lechler.com/de-en/service/loss-reducing

Application:



Herbicide pre-emergence



Liquid fertilizer delivery



Golf course

Technical data:



Nozzle size 05



Spray angle 130°



Material POM



Pressure ranges
• 1.5–8 bar
• UAN: 1.5–4 bar



Recommended strainer 25 M



Droplet size Ultra coarse

	ISO 25358	[l/min]	[l/ha] 									
			5.0 km/h	6.0 km/h	7.0 km/h	8.0 km/h	10.0 km/h	12.0 km/h	14.0 km/h	16.0 km/h	18.0 km/h	
PRE 130-05 (25 M)	UC	1.5	1.55	372	310	266	233	186	155	133	116	103
	UC	2.0	1.73	415	346	297	260	208	173	148	130	115
	UC	3.0	2.00	480	400	343	300	240	200	171	150	133
	UC	4.0	2.24	538	448	384	336	269	224	192	168	149
	UC	5.0	2.45	588	490	420	368	294	245	210	184	163
	UC	6.0	2.64	634	528	453	396	317	264	226	198	176
	UC	7.0	2.82	677	564	483	423	338	282	242	212	188
	UC	8.0	2.99	718	598	513	449	359	299	256	224	199



ISO 25358 classification according to droplet sizes:

VF	Very fine
F	Fine
M	Medium
C	Coarse
VC	Very coarse
EC	Extremely coarse
UC	Ultra coarse

Subject to modifications.

- Operating pressure at the nozzle (measured with diaphragm valve)
- The stated liter-per-hectare rates apply to water
- Verify the table values by gauging the flow rates prior to every spraying season
- Pay attention to uniform nozzle adjustment

 **Nozzle calculator app**

The apps for Lechler agricultural nozzles make selection and use of the optimum nozzle even easier. Find out more here: www.lechler.com/de-en/service/apps

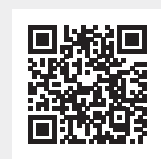

Ordering Series + Nozzle size + Material = Order No.
 example: PRE + 05 + (POM) = PRE 05

Anti-drift flat spray nozzles AD 120/AD 90

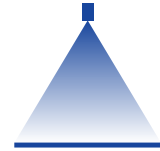

Crop production / Ground care

Dimensions in mm.

- Low-drift flat spray nozzle

Advantages

- Application with medium to coarse droplets even with low l/ha rates
- Optimized atomization and reduced fine droplet share thanks to integrated pre-chamber
- Pre-atomizer can be removed without tools
- NEW** • Pre-atomizer has flush contact with twist lock
- Pre-atomizer can be removed for cleaning
- Compact design
- Suitable for PWM



AD

AD-C

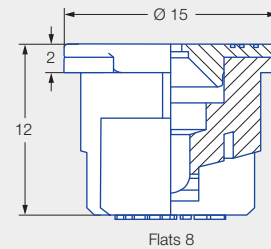

Flats 8

Series AD



Removable pre-atomizer

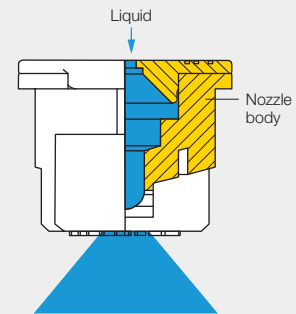

Application:

Plant protection products and growth regulators

Backpack sprayer

Greenhouse

Technical data:

Nozzle sizes
015-04

Spray angles
90°, 120°

Materials
POM, ceramic

Pressure ranges
1.5-3-6 bar

Recommended strainers

- 80 M 015
- 60 M 02-04

Droplet sizes
Coarse - fine

Width across flats
8 mm

	ISO 25358	[l/min]	[l/ha] 									
			5.0 km/h	6.0 km/h	7.0 km/h	8.0 km/h	10.0 km/h	12.0 km/h	14.0 km/h	16.0 km/h	18.0 km/h	
AD 120-015 90-015 (80 M)	M	1.5	0.42	101	84	72	63	50	42	36	32	28
	M	2.0	0.48	115	96	82	72	58	48	41	36	32
	M	2.5	0.54	130	108	93	81	65	54	45	41	36
	M	3.0	0.59	142	118	101	89	71	59	51	44	39
	F	3.5	0.63	151	126	108	95	76	63	54	47	42
	F	4.0	0.68	163	136	117	102	82	68	58	51	45
	F	4.5	0.72	173	144	123	108	86	72	62	54	48
	F	5.0	0.76	182	152	130	114	91	76	65	57	51
	F	6.0	0.83	199	166	142	125	100	83	72	62	55
AD 120-02 90-02 (60 M)	M	1.5	0.56	134	112	96	84	67	56	47	42	37
	M	2.0	0.65	156	130	111	98	78	65	54	49	43
	M	2.5	0.73	175	146	125	110	88	73	61	55	49
	M	3.0	0.80	192	160	137	120	96	80	67	60	53
	F	3.5	0.86	206	172	147	129	103	86	73	65	57
	F	4.0	0.92	221	184	158	138	110	92	77	69	61
	F	4.5	0.98	235	196	168	147	118	98	82	74	65
	F	5.0	1.03	247	206	177	155	124	103	87	77	69
	F	6.0	1.13	271	226	194	170	136	113	95	85	75
AD 120-03 90-03 (60 M)	M	1.5	0.84	202	168	144	126	101	84	70	63	56
	M	2.0	0.97	233	194	166	146	116	97	81	73	65
	M	2.5	1.08	259	216	185	162	130	108	91	81	72
	M	3.0	1.19	286	238	204	179	143	119	100	89	79
	M	3.5	1.28	307	256	219	192	154	128	108	96	85
	F	4.0	1.37	329	274	235	206	164	137	116	103	91
	F	4.5	1.46	350	292	250	219	175	146	123	110	97
	F	5.0	1.53	367	306	262	230	184	153	130	115	102
	F	6.0	1.68	403	336	288	252	202	168	141	126	112
AD 120-04 90-04 (60 M)	C	1.5	1.12	269	224	192	168	134	112	93	84	75
	C	2.0	1.29	310	258	221	194	155	129	108	97	86
	M	2.5	1.44	346	288	247	216	173	144	122	108	96
	M	3.0	1.58	379	316	271	237	190	158	133	119	105
	M	3.5	1.71	410	342	293	257	205	171	144	128	114
	M	4.0	1.82	437	364	312	273	218	182	154	137	121
	M	4.5	1.94	466	388	333	291	233	194	164	146	129
	M	5.0	2.04	490	408	350	306	245	204	173	153	136
	M	6.0	2.23	535	446	382	335	268	223	189	167	149

ISO 25358 classification according to droplet sizes:

VF	Very fine
F	Fine
M	Medium
C	Coarse
VC	Very coarse
EC	Extremely coarse
UC	Ultra coarse

Subject to modifications.

- Operating pressure at the nozzle (measured with diaphragm valve)
- The stated liter-per-hectare rates apply to water
- Verify the table values by gauging the flow rates prior to every spraying season
- Pay attention to uniform nozzle adjustment

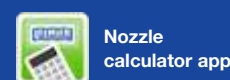

The apps for Lechler agricultural nozzles make selection and use of the optimum nozzle even easier. Find out more here: www.lechler.com/de-en/service/apps

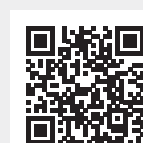

Ordering	Series	+ Spray angle	+ Nozzle size	+ Material	= Order No.
example:	AD	+ 120°	+ 02	+ (POM)	= AD 120-02
	AD	+ 120°	+ 02	+ C (Ceramic)	= AD 120-02 C

Multirange flat spray nozzles

LU 120/LU 90



Crop production / **Ground care**

Dimensions in mm.

- Universal flat spray nozzle with fine droplet spectrum

Advantages

- Extended pressure range
- Low drift in the pressure range up to 2.5 bar
- Fine-droplet application
- High manufacturing quality
- Suitable for PWM



LU



LU-C



LU-S



G 1240, G 1242, G 1524,
G 1596

Series LU

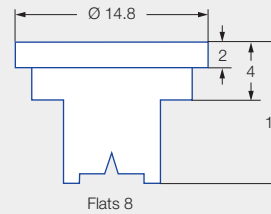

Application:



Plant protection products and growth regulators



Edge application
Can be combined with border nozzle OC



Backpack sprayer



Greenhouse

Technical data:



Nozzle sizes
01–08



Spray angles
90°, 120°



Materials
POM, ceramic,
stainless steel



Pressure ranges
1.5–2.5–5 bar



Recommended strainers

- 80 M 01–015
- 60 M 02–04
- 25 M 05–08



Droplet sizes
Coarse – very fine



Width across flats
8 mm

	ISO 25358	[l/min]	[l/ha]									
			5.0 km/h	6.0 km/h	7.0 km/h	8.0 km/h	10.0 km/h	12.0 km/h	14.0 km/h	16.0 km/h	18.0 km/h	
LU 120-01 90-01 (80 M)	F	1.5	0.28	67	56	48	42	34	28	24	21	19
	F	2.0	0.32	77	64	55	48	38	32	27	24	21
	F	3.0	0.39	94	78	67	59	47	39	33	29	26
	F	4.0	0.45	108	90	77	68	54	45	39	34	30
	VF	5.0	0.51	122	102	87	77	61	51	44	38	34
LU 120-015 90-015 (80 M)	F	1.5	0.42	101	84	72	63	50	42	36	32	28
	F	2.0	0.48	115	96	82	72	58	48	41	36	32
	F	3.0	0.59	142	118	101	89	71	59	51	44	39
	F	4.0	0.68	163	136	117	102	82	68	58	51	45
	VF	5.0	0.76	182	152	130	114	91	76	65	57	51
LU 120-02 90-02 (60 M)	M	1.5	0.56	134	112	96	84	67	56	48	42	37
	F	2.0	0.65	156	130	111	98	78	65	56	49	43
	F	3.0	0.80	192	160	137	120	96	80	69	60	53
	F	4.0	0.92	221	184	158	138	110	92	79	69	61
	F	5.0	1.03	247	206	177	155	124	103	88	77	69
LU 120-025 (60 M)	M	1.5	0.70	168	140	120	105	84	70	60	53	47
	F	2.0	0.81	194	162	139	122	97	81	69	61	54
	F	3.0	0.99	238	198	170	149	119	99	85	74	66
	F	4.0	1.15	276	230	197	173	138	115	99	86	77
	F	5.0	1.28	307	256	219	192	154	128	110	96	85
LU 120-03 90-03 (60 M)	M	1.5	0.84	202	168	144	126	101	84	72	63	56
	F	2.0	0.97	233	194	166	146	116	97	83	73	65
	F	3.0	1.19	286	238	204	179	143	119	102	89	79
	F	4.0	1.37	329	274	235	206	164	137	117	103	91
	F	5.0	1.53	367	306	262	230	184	153	131	115	102
LU 120-04 90-04 (60 M)	M	1.5	1.12	269	224	192	168	134	112	96	84	75
	M	2.0	1.29	310	258	221	194	155	129	111	97	86
	F	3.0	1.58	379	316	271	237	190	158	135	119	105
	F	4.0	1.82	437	364	312	273	218	182	156	137	121
	F	5.0	2.04	490	408	350	306	245	204	175	153	136
LU 120-05 90-05 (25 M)	M	1.5	1.39	334	278	238	209	167	139	119	104	93
	M	2.0	1.61	386	322	276	242	193	161	138	121	107
	F	3.0	1.97	473	394	338	296	236	197	169	148	131
	F	4.0	2.28	547	456	391	342	274	228	195	171	152
	F	5.0	2.55	612	510	437	383	306	255	219	191	170
LU 120-06 90-06 (25 M)	M	1.5	1.67	401	334	286	251	200	167	143	125	111
	M	2.0	1.93	463	386	331	290	232	193	165	145	129
	F	3.0	2.36	566	472	405	354	283	236	202	177	157
	F	4.0	2.73	655	546	468	410	328	273	234	205	182
	F	5.0	3.05	732	610	523	458	366	305	261	229	203
LU 120-08 90-08 (25 M)	C	1.5	2.23	535	446	382	335	268	223	191	167	149
	M	2.0	2.58	619	516	442	387	310	258	221	194	172
	M	3.0	3.16	758	632	542	474	379	316	271	237	211
	M	4.0	3.65	876	730	626	548	438	365	313	274	243
	M	5.0	4.08	979	816	699	612	490	408	350	306	272

ISO 25358 classification according to droplet sizes:

VF	Very fine
F	Fine
M	Medium
C	Coarse
VC	Very coarse
EC	Extremely coarse
UC	Ultra coarse

Subject to modifications.

- Operating pressure at the nozzle (measured with diaphragm valve)
- The stated liter-per-hectare rates apply to water
- Verify the table values by gauging the flow rates prior to every spraying season
- Pay attention to uniform nozzle adjustment

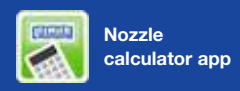

The apps for Lechler agricultural nozzles make selection and use of the optimum nozzle even easier. Find out more here: www.lechler.com/de-en/service/apps



Ordering example:	Series	+ Spray angle	+ Nozzle size	+ Material	= Order No.
	LU	+ 120°	+ 02	+ (POM)	= LU 120-02
	LU	+ 120°	+ 015	+ C (Ceramic)	= LU 120-015 C
	LU	+ 120°	+ 03	+ S (stainless steel)	= LU 120-03 S

Quality flat spray nozzles

QS 80

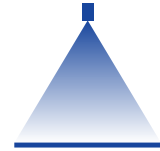

Crop production

Ground care

Dimensions in mm.

- Universal flat spray nozzle made of ceramic material
- For lower l/ha rates and higher workrates

Advantages

- 80° flat spray reduces drift in comparison with 110°/120° flat spray
- Higher droplet density due to optimized fine droplet spectrum
- Lower flow rate tolerance of +1/-3% due to high manufacturing quality
- Optimum cross distribution for boom heights of 0.6 to 0.9 m
- High wear resistance thanks to ceramic tip
- Suitable for PWM



Series QS 80

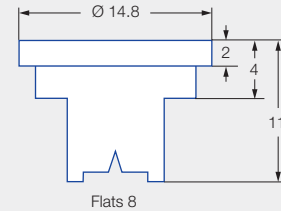

Application:



Plant protection products and growth regulators



Edge application
Can be combined with border nozzle OC

Technical data:



Nozzle sizes
015-025



Spray angle
80°



Material
Ceramic



Pressure ranges
1.5-5 bar



Recommended strainers

- 80 M 015
- 60 M 02-025





Droplet sizes
Medium - fine



Width across flats
8 mm



Spray heights
60-90 cm

	ISO 25358	[l/min]	[l/ha]											
			5.0 km/h	6.0 km/h	7.0 km/h	8.0 km/h	9.0 km/h	10.0 km/h	12.0 km/h	14.0 km/h	16.0 km/h	18.0 km/h	20.0 km/h	
 QS 80-015 (80 M)	F	1.5	0.42	101	84	72	63	56	50	42	36	32	28	25
	F	2.0	0.48	115	96	82	72	64	58	48	41	36	32	29
	F	2.5	0.54	130	108	93	81	72	65	54	46	41	36	32
	F	3.0	0.59	142	118	101	89	79	71	59	51	44	39	35
	F	3.5	0.63	151	126	108	95	84	76	63	54	47	42	38
	F	4.0	0.68	163	136	117	102	91	82	68	58	51	45	41
	F	5.0	0.76	182	152	130	114	101	91	76	65	57	51	46
 QS 80-02 (60 M)	M	1.5	0.56	134	112	96	84	75	67	56	48	42	37	34
	F	2.0	0.65	156	130	111	98	87	78	65	56	49	43	39
	F	2.5	0.73	175	146	125	110	97	88	73	63	55	49	44
	F	3.0	0.80	192	160	137	120	107	96	80	69	60	53	48
	F	3.5	0.86	206	172	147	129	115	103	86	74	65	57	52
	F	4.0	0.92	221	184	158	138	123	110	92	79	69	61	55
	F	5.0	1.03	247	206	177	155	137	124	103	97	77	69	62
 QS 80-025 (60 M)	M	1.5	0.70	168	140	120	105	93	84	70	60	53	47	42
	F	2.0	0.81	194	162	139	122	108	97	81	69	61	54	49
	F	2.5	0.91	218	182	156	137	121	109	91	78	68	61	55
	F	3.0	0.99	238	198	170	149	132	119	99	85	74	66	59
	F	3.5	1.07	257	214	183	161	143	129	107	92	80	71	64
	F	4.0	1.15	276	230	197	173	153	138	115	99	86	77	69
	F	5.0	1.28	307	256	219	192	171	154	128	110	96	85	77

ISO 25358 classification according to droplet sizes:

- VF** Very fine
- F** Fine
- M** Medium
- C** Coarse
- VC** Very coarse
- EC** Extremely coarse
- UC** Ultra coarse

Subject to modifications.

- Operating pressure at the nozzle (measured with diaphragm valve)
- The stated liter-per-hectare rates apply to water
- Verify the table values by gauging the flow rates prior to every spraying season
- Pay attention to uniform nozzle adjustment



Ordering Series + Nozzle size + Material = Order No.
 example: QS 80 + 015 + C (Ceramic) = QS 80-015 C



Standard flat spray nozzles

ST 110/ST 80 / SC 110/SC 80

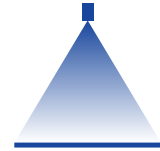

Crop production

Ground care

Dimensions in mm.

- Standard flat spray nozzle (ST)
- Nozzle-in-cap system MULTIJET (SC)

Advantages

- Color coding in accordance with ISO Standard 10625
- Inexpensive flat spray nozzle
- SC: Nozzle in cap with MULTIJET bayonet system (incl. gasket) for
 - lower assembly and storage costs
 - simple and fast assembly
- Suitable for PWM



ST



ST-C



SC

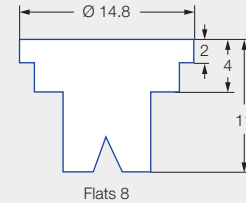

Series ST/SC

Application:



Plant protection products and growth regulators



Edge application
Can be combined with border nozzle OC



Backpack sprayer
Series ST only

Technical data:



Nozzle sizes
01–08



Spray angles
80°, 110°



Materials
POM, ceramic,
brass on request



Pressure ranges

- SC 025 to -05:
2–3–5 bar
- ST 01 to -08:
2–3–5 bar



Recommended strainers

- 80 M 01–015
- 60 M 02–04
- 25 M 05–08



Droplet sizes
Coarse – very fine





Width across flats
8 mm



Spray heights

- ST 80°:
60–**75**–90 cm
- ST 110°:
40–**50**–60 cm

			[l/min]	[l/ha] 							
				5.0 km/h	6.0 km/h	7.0 km/h	8.0 km/h	10.0 km/h	12.0 km/h	14.0 km/h	16.0 km/h
ST 110-01 80-01 (80 M)	2.0	0.32	77	64	55	48	38	32	27	24	21
	2.5	0.36	86	72	62	54	43	36	31	27	24
	3.0	0.39	94	78	67	59	47	39	33	29	26
	4.0	0.45	108	90	77	68	54	45	39	34	30
ST 110-015 80-015 (80 M)	2.0	0.48	115	96	82	72	58	48	41	36	32
	2.5	0.54	130	108	93	81	65	54	46	41	36
	3.0	0.59	142	118	101	89	71	59	51	44	39
	4.0	0.68	163	136	117	102	82	68	58	51	45
ST 110-02 80-02 (60 M)	2.0	0.65	156	130	111	98	78	65	56	49	43
	2.5	0.73	175	146	125	110	88	73	63	55	49
	3.0	0.80	192	160	137	120	96	80	69	60	53
	4.0	0.92	221	184	158	138	110	92	79	69	61
SC/ST 110-025 (60 M)	2.0	0.81	194	162	139	122	97	81	69	61	54
	2.5	0.91	218	182	156	137	109	91	78	68	61
	3.0	0.99	238	198	170	149	119	99	85	74	66
	4.0	1.15	276	230	197	173	138	115	99	86	77
SC/ST 110-03 80-03 (60 M)	2.0	0.97	233	194	166	146	116	97	83	73	65
	2.5	1.08	259	216	185	162	130	108	93	81	72
	3.0	1.19	286	238	204	179	143	119	102	89	79
	4.0	1.37	329	274	235	206	164	137	117	103	91
SC/ST 110-04 80-04 (60 M)	2.0	1.29	310	258	221	194	155	129	111	97	86
	2.5	1.44	346	288	247	216	173	144	123	108	96
	3.0	1.58	379	316	271	237	190	158	135	119	105
	4.0	1.82	437	364	312	273	218	182	156	137	121
SC/ST 110-05 80-05 (25 M)	2.0	1.61	386	322	276	242	193	161	138	121	107
	2.5	1.80	432	360	309	270	216	180	154	135	120
	3.0	1.97	473	394	338	296	236	197	169	148	131
	4.0	2.28	547	456	391	342	274	228	195	171	152
ST 110-06 80-06 (25 M)	2.0	1.93	463	386	331	290	232	193	165	145	129
	2.5	2.16	518	432	370	324	259	216	185	162	144
	3.0	2.36	566	472	405	354	283	236	202	177	157
	4.0	2.73	655	546	468	410	328	273	234	205	182
ST 110-08 80-08 (25 M)	2.0	2.58	619	516	442	387	310	258	221	194	172
	2.5	2.88	691	576	494	432	346	288	247	216	192
	3.0	3.16	758	632	542	474	379	316	271	237	211
	4.0	3.65	876	730	626	548	438	365	313	274	243
	5.0	4.08	979	816	699	612	490	408	350	306	272

- Operating pressure at the nozzle (measured with diaphragm valve)
- The stated liter-per-hectare rates apply to water
- Verify the table values by gauging the flow rates prior to every spraying season
- Pay attention to uniform nozzle adjustment

Ordering	Series	+ Spray angle	+ Nozzle size	+ Material	= Order No.
example:	SC	+ 110°	+ 03	+ (POM)	= SC 110-03
	ST	+ 110°	+ 06	+ (POM)	= ST 110-06
	ST	+ 110°	+ 06	+ C (Ceramic)	= ST 110-06 C

➤➤ Twin flat spray nozzles XDT 130

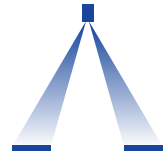

Crop production / **Ground care**

- Extreme drift reduction over the entire pressure range
- Symmetrical twin flat spray jet 40°/40° to the front/rear

Advantages

- High workrate due to wide control range
- Optimum deposition with reduced spray shadow
- Nozzle in cap with MULTIJET bayonet system (incl. gasket)
- For timely application even under adverse weather conditions
- Suitable for PWM



Series XDT 130



Dosing orifice with basket, can be removed without tools

Dimensions in mm.

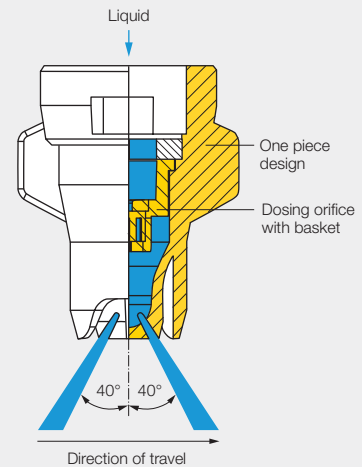
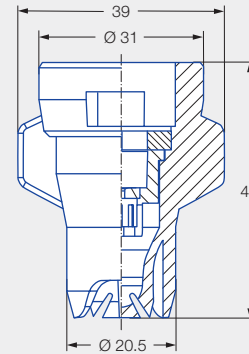

Application:

Plant protection products

Golf course

Technical data:

Nozzle sizes
02-08



Spray angle
130°

Material
POM

Pressure ranges
1.5-8 bar

Recommended strainers
60 M 02-08

Droplet sizes
Ultra coarse - extremely coarse

			[l/min]	[l/ha] 							
				5.0 km/h	6.0 km/h	7.0 km/h	8.0 km/h	10.0 km/h	12.0 km/h	14.0 km/h	16.0 km/h
XDT 130-02 (60 M)	1.5	0.56	134	112	96	84	67	56	48	42	37
	2.0	0.65	156	130	111	98	78	65	56	49	43
	3.0	0.80	192	160	137	120	96	80	69	60	53
	4.0	0.92	221	184	158	138	110	92	79	69	61
	5.0	1.03	247	206	177	155	124	103	88	77	69
	6.0	1.13	271	226	194	170	136	113	97	85	75
	7.0	1.22	293	244	209	183	146	122	105	92	81
	8.0	1.30	312	260	223	195	156	130	111	98	87
XDT 130-025 (60 M)	1.5	0.70	168	140	120	105	84	70	60	53	47
	2.0	0.81	194	162	139	122	97	81	69	61	54
	3.0	0.99	238	198	170	149	119	99	85	74	66
	4.0	1.15	276	230	197	173	138	115	99	86	77
	5.0	1.28	307	256	219	192	154	128	110	96	85
	6.0	1.40	336	280	240	210	168	140	120	105	93
	7.0	1.52	365	304	261	228	182	152	130	114	101
	8.0	1.62	389	324	278	243	194	162	139	122	108
XDT 130-03 (60 M)	1.5	0.84	202	168	144	126	101	84	72	63	56
	2.0	0.97	233	194	166	146	116	97	83	73	65
	3.0	1.19	286	238	204	179	143	119	102	89	79
	4.0	1.37	329	274	235	206	164	137	117	103	91
	5.0	1.53	367	306	262	230	184	153	131	115	102
	6.0	1.68	403	336	288	252	202	168	144	126	112
	7.0	1.81	434	362	310	272	217	181	155	136	121
	8.0	1.94	466	388	333	291	233	194	166	146	129
XDT 130-04 (60 M)	1.5	1.12	269	224	192	168	134	112	96	84	75
	2.0	1.29	310	258	221	194	155	129	111	97	86
	3.0	1.58	379	316	271	237	190	158	135	119	105
	4.0	1.82	437	364	312	273	218	182	156	137	121
	5.0	2.04	490	408	350	306	245	204	175	153	136
	6.0	2.23	535	446	382	335	268	223	191	167	149
	7.0	2.41	578	482	413	362	289	241	207	181	161
	8.0	2.58	619	516	442	387	310	258	221	194	172
XDT 130-05 (60 M)	1.5	1.39	334	278	238	209	167	139	119	104	93
	2.0	1.61	386	322	276	242	193	161	138	121	107
	3.0	1.97	473	394	338	296	236	197	169	148	131
	4.0	2.28	547	456	391	342	274	228	195	171	152
	5.0	2.55	612	510	437	383	306	255	219	191	170
	6.0	2.79	670	558	478	419	335	279	239	209	186
	7.0	3.01	722	602	516	452	361	301	258	226	201
	8.0	3.22	773	644	552	483	386	322	276	242	215
XDT 130-06 (60 M)	1.5	1.67	401	334	286	251	200	167	143	125	111
	2.0	1.93	463	386	331	290	232	193	165	145	129
	3.0	2.36	566	472	405	354	283	236	202	177	157
	4.0	2.73	655	546	468	410	328	273	234	205	182
	5.0	3.05	732	610	523	458	366	305	261	229	203
	6.0	3.34	802	668	573	501	401	334	286	251	223
	7.0	3.61	866	722	619	542	433	361	309	271	241
	8.0	3.86	926	772	662	579	463	386	331	290	257
XDT 130-08 (60 M)	1.5	2.23	535	446	382	335	268	223	191	167	149
	2.0	2.58	619	516	442	387	310	258	221	194	172
	3.0	3.16	758	632	542	474	379	316	271	237	211
	4.0	3.65	876	730	626	548	438	365	313	274	243
	5.0	4.08	979	816	699	612	490	408	350	306	272
	6.0	4.47	1,073	894	766	671	536	447	383	335	298
	7.0	4.83	1,159	966	828	725	580	483	414	362	322
	8.0	5.16	1,238	1,032	885	774	619	516	442	387	344

- Operating pressure at the nozzle (measured with diaphragm valve)
- The stated liter-per-hectare rates apply to water
- Verify the table values by gauging the flow rates prior to every spraying season
- Pay attention to uniform nozzle adjustment

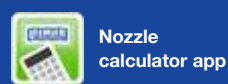

The apps for Lechler agricultural nozzles make selection and use of the optimum nozzle even easier. Find out more here: www.lechler.com/de-en/service/apps



Ordering Series + Nozzle size + Material = Order No.
example: XDT 130 + 02 + (POM) = XDT 130-02

Asymmetrical air-injector twin flat spray nozzles IDTA

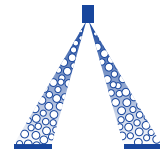

Crop production

Ground care



Dimensions in mm.

- Air-aspirating asymmetrical twin flat spray nozzle
- Extremely low-drift

Advantages

- 95 % drift reduction for: IDTA 120-05 C
- 90 % drift reduction for: IDTA 120-025 C to -04 C
- Ideal for higher sprayer speeds due to 30°/50° spray configuration
- Uniform deposition through 60/40 flow rate distribution
- Identical spray width on the target area due to 90°/120° spray angle
- Optimum wetting through finer droplet spectrum to the front in direction of travel
- Drift-reducing coarser droplet spectrum to the rear
- Optimum user protection thanks to removal/installation of the injector with protective gloves without tools
- Nozzle in cap with MULTIJET bayonet system (incl. gasket)
- Suitable for PWM



Series IDTA



Injector can be removed without tools

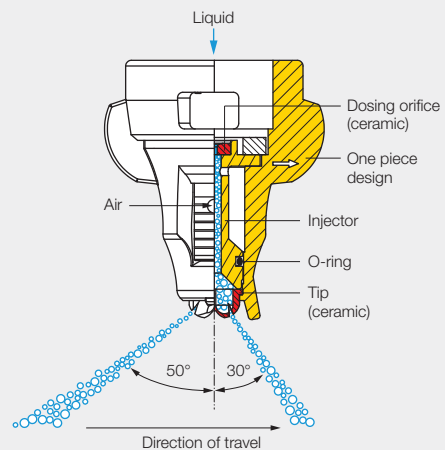
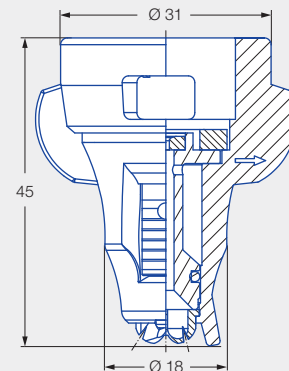

JKI approval as loss-reducing: 95/90/75 %

G 2015, G 2016, G 2017, G 2018, G 2019, G 2020, G 2021, G 2022, G 2043

JKI approval for mixed equipment and border nozzle IS.



Current list at: www.lechler.com/de-en/service/loss-reducing

Rear spray angle 90 (40 % spray volume)

Front spray angle 120 (60 % spray volume)

Application:



Plant protection products



Edge application
Can be combined with border nozzle IS 80



Golf course

Technical data:



Nozzle sizes
02-08



Spray angle
120° front/
90° rear



Material
Ceramic



Pressure ranges
1-4-8 bar



Recommended strainers

- 80 M 02
- 60 M 025-08



Droplet sizes
Ultra coarse - coarse

	ISO 25358	[l/min]	[l/ha]									
			5.0 km/h	6.0 km/h	7.0 km/h	8.0 km/h	10.0 km/h	12.0 km/h	14.0 km/h	16.0 km/h	18.0 km/h	
IDTA 120-02 (80 M)	UC	1.0	0.46	110	92	79	69	55	46	39	35	31
	UC	1.5	0.56	134	112	96	84	67	56	48	42	37
	UC	2.0	0.65	156	130	111	98	78	65	56	49	43
	VC	3.0	0.80	192	160	137	120	96	80	69	60	53
	VC	4.0	0.92	221	184	158	138	110	92	79	69	61
	VC	5.0	1.03	247	206	177	155	124	103	88	77	69
	VC	6.0	1.13	271	226	194	170	136	113	97	85	75
	VC	7.0	1.22	293	244	209	183	146	122	105	92	81
IDTA 120-025 (60 M)	UC	1.0	0.57	137	114	98	86	68	57	49	43	38
	UC	1.5	0.70	168	140	120	105	84	70	60	53	47
	UC	2.0	0.81	194	162	139	122	97	81	69	61	54
	EC	3.0	0.99	238	198	170	149	119	99	85	74	66
	VC	4.0	1.15	276	230	197	173	138	115	99	86	77
	VC	5.0	1.28	307	256	219	192	154	128	110	96	85
	VC	6.0	1.40	336	280	240	210	168	140	120	105	93
	VC	7.0	1.52	365	304	261	228	182	152	130	114	101
IDTA 120-03 (60 M)	UC	1.0	0.69	166	138	118	104	83	69	59	52	46
	UC	1.5	0.84	202	168	144	126	101	84	72	63	56
	EC	2.0	0.97	233	194	166	146	116	97	83	73	65
	VC	3.0	1.19	286	238	204	179	143	119	102	89	79
	VC	4.0	1.37	329	274	235	206	164	137	117	103	91
	VC	5.0	1.53	367	306	262	230	184	153	131	115	102
	VC	6.0	1.68	403	336	288	252	202	168	144	126	112
	VC	7.0	1.81	434	362	310	272	217	181	155	136	121
IDTA 120-04 (60 M)	UC	1.0	0.91	218	182	156	137	109	91	78	68	61
	UC	1.5	1.12	269	224	192	168	134	112	96	84	75
	EC	2.0	1.29	310	258	221	194	155	129	111	97	86
	VC	3.0	1.58	379	316	271	237	190	158	135	119	105
	VC	4.0	1.82	437	364	312	273	218	182	156	137	121
	VC	5.0	2.04	490	408	350	306	245	204	175	153	136
	VC	6.0	2.23	535	446	382	335	268	223	191	167	149
	VC	7.0	2.41	578	482	413	362	289	241	207	181	161
IDTA 120-05 (60 M)	UC	1.0	1.14	274	228	195	171	137	114	98	86	76
	UC	1.5	1.39	334	278	238	209	167	139	119	104	93
	EC	2.0	1.61	386	322	276	242	193	161	138	121	107
	VC	3.0	1.97	473	394	338	296	236	197	169	148	131
	VC	4.0	2.28	547	456	391	342	274	228	195	171	152
	VC	5.0	2.55	612	510	437	383	306	255	219	191	170
	VC	6.0	2.79	670	558	478	419	335	279	239	209	186
	C	7.0	3.01	722	602	516	452	361	301	258	226	201
IDTA 120-06 (60 M)	UC	1.0	1.36	326	272	233	204	163	136	117	102	91
	UC	1.5	1.67	401	334	286	251	200	167	143	125	111
	EC	2.0	1.93	463	386	331	290	232	193	165	145	129
	VC	3.0	2.36	566	472	405	354	283	236	202	177	157
	VC	4.0	2.73	655	546	468	410	328	273	234	205	182
	VC	5.0	3.05	732	610	523	458	366	305	261	229	203
	VC	6.0	3.34	802	668	573	501	401	334	286	251	223
	C	7.0	3.61	866	722	619	542	433	361	309	271	241
IDTA 120-08 (60 M)	UC	1.0	1.82	437	364	312	273	218	182	156	137	121
	UC	1.5	2.23	535	446	382	335	268	223	191	167	149
	EC	2.0	2.58	619	516	442	387	310	258	221	194	172
	VC	3.0	3.16	758	632	542	474	379	316	271	237	211
	VC	4.0	3.65	876	730	626	548	438	365	313	274	243
	VC	5.0	4.08	979	816	699	612	490	408	350	306	272
	VC	6.0	4.47	1,073	894	766	671	536	447	383	335	298
	C	7.0	4.83	1,159	966	828	725	580	483	414	362	322
C	8.0	5.16	1,238	1,032	885	774	619	516	442	387	344	

ISO 25358 classification according to droplet sizes:

- VF** Very fine
- F** Fine
- M** Medium
- C** Coarse
- VC** Very coarse
- EC** Extremely coarse
- UC** Ultra coarse

Subject to modifications.

- Operating pressure at the nozzle (measured with diaphragm valve)
- The stated liter-per-hectare rates apply to water
- Verify the table values by gauging the flow rates prior to every spraying season
- Pay attention to uniform nozzle adjustment

Recommendation

You can find adapters for other bayonet systems on Page 125.

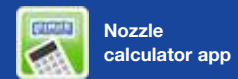

The apps for Lechler agricultural nozzles make selection and use of the optimum nozzle even easier.

Find out more here:
www.lechler.com/de-en/service/apps



Ordering example: Series IDTA + Spray angle + 120° + Nozzle size + 025 + Material + C (Ceramic) = Order No. IDTA 120-025 C

Compact symmetrical air-injector twin flat spray nozzles IDKT

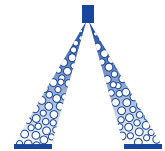

Crop production / **Ground care**

- Very low-drift, air-aspirating twin flat spray nozzle

Advantages

- Optimum deposition thanks to symmetrical twin flat spray jet 30°/30°
- Reduced spray shadow
- 90% drift reduction for: IDKT 120-02 to -06
- Compact design
- Low drift and loss-reducing in the pressure range up to 3 bar (depending on size)
- Suitable for PWM



IDKT

IDKT-C

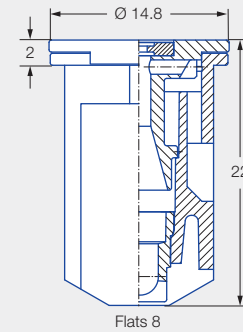

Dimensions in mm.

Series IDKT



Injector can be removed without tools

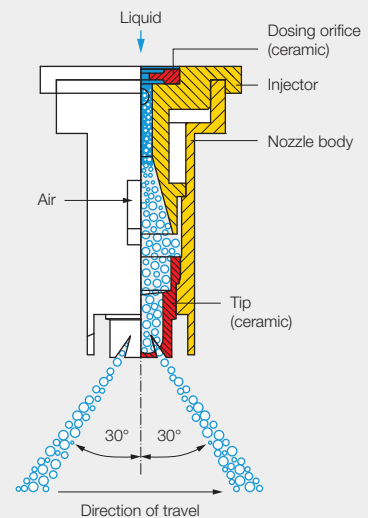

JKI approval as loss-reducing: 90/75/50%

G 1836, G 1837, G 1865, G 1882, G 1883, G 1884, G 1911, G 1912, G 1932, G 1933, G 1934, G 1935, G 1937

JKI approval for mixed equipment and border nozzle IS.



Current list at: www.lechler.com/de-en/service/loss-reducing

Application:



Plant protection products



Spray frame



Edge application
Can be combined with border nozzle IDKS 80



Golf course



Greenhouse

Technical data:



Nozzle sizes
015-10



Spray angle
120°



Materials
POM, ceramic



Pressure ranges

- IDKT 015 bis -025
1.5-3 bar
- IDKT 03 bis -06
1-1.5-3 bar



Recommended strainers

- 80 M 015-02
- 60 M 025-08
- 25 M 10



Droplet sizes
Ultra coarse - medium



Width across flats
8 mm

	ISO 25358	[l/min]	[l/ha]									
			5.0 km/h	6.0 km/h	7.0 km/h	8.0 km/h	10.0 km/h	12.0 km/h	14.0 km/h	16.0 km/h	18.0 km/h	
IDKT 120-015 (80 M)	UC	1.5	0.42	101	84	72	63	50	42	36	32	28
	EC	2.0	0.48	115	96	82	72	58	48	41	36	32
	VC	3.0	0.59	142	118	101	89	71	59	51	44	39
	VC	4.0	0.68	163	136	117	102	82	68	58	51	45
	VC	5.0	0.76	182	152	130	114	91	76	65	57	51
	VC	6.0	0.83	199	166	142	125	100	83	71	62	55
IDKT 120-02 (80 M)	EC	1.5	0.56	134	112	96	84	67	56	48	42	37
	EC	2.0	0.65	156	130	111	98	78	65	56	49	43
	VC	3.0	0.80	192	160	137	120	96	80	69	60	53
	VC	4.0	0.92	221	184	158	138	110	92	79	69	61
	C	5.0	1.03	247	206	177	155	124	103	88	77	69
	C	6.0	1.13	271	226	194	170	136	113	97	85	75
IDKT 120-025 (60 M)	EC	1.5	0.70	168	140	120	105	84	70	60	53	47
	VC	2.0	0.81	194	162	139	122	97	81	69	61	54
	VC	3.0	0.99	238	198	170	149	119	99	85	74	66
	VC	4.0	1.15	276	230	197	173	138	115	99	86	77
	C	5.0	1.28	307	256	219	192	154	128	110	96	85
	M	6.0	1.40	336	280	240	210	168	140	120	105	93
IDKT 120-03 (60 M)	UC	1.0	0.69	166	138	118	104	83	69	59	51	45
	EC	1.5	0.84	202	168	144	126	101	84	72	63	56
	EC	2.0	0.97	233	194	166	146	116	97	83	73	65
	VC	3.0	1.19	286	238	204	179	143	119	102	89	79
	VC	4.0	1.37	329	274	235	206	164	137	117	103	91
	C	5.0	1.53	367	306	262	230	184	153	131	115	102
IDKT 120-04 (60 M)	EC	1.0	0.91	218	182	156	137	109	91	78	68	61
	EC	1.5	1.12	269	224	192	168	134	112	96	84	75
	VC	2.0	1.29	310	258	221	194	155	129	111	97	86
	VC	3.0	1.58	379	316	271	237	190	158	135	119	105
	VC	4.0	1.82	437	364	312	273	218	182	156	137	121
	C	5.0	2.04	490	408	350	306	245	204	175	153	136
IDKT 120-05 (60 M)	C	6.0	2.23	535	446	382	335	268	223	191	167	149
	UC	1.0	1.14	274	228	195	171	137	114	98	86	76
	EC	1.5	1.39	334	278	238	209	167	139	119	104	93
	VC	2.0	1.61	386	322	276	242	193	161	138	121	107
	VC	3.0	1.97	473	394	338	296	236	197	169	148	131
	VC	4.0	2.28	547	456	391	342	274	228	195	171	152
IDKT 120-06 (60 M)	C	5.0	2.55	612	510	437	383	306	255	219	191	170
	C	6.0	2.79	670	558	478	419	335	279	239	209	186
	UC	1.0	1.36	326	272	233	204	163	136	117	102	91
	EC	1.5	1.67	401	334	286	251	200	167	143	125	111
	VC	2.0	1.93	463	386	331	290	232	193	165	145	129
	VC	3.0	2.36	566	472	405	354	283	236	202	177	157
IDKT 120-08 (60 M)	VC	4.0	2.73	655	546	468	410	328	273	234	205	182
	C	5.0	3.05	732	610	523	458	366	305	261	229	203
	C	6.0	3.34	802	668	573	501	401	334	286	251	223
	EC	1.0	1.82	437	364	312	273	218	182	156	137	121
	EC	1.5	2.23	535	446	382	335	268	223	191	167	149
	VC	2.0	2.58	619	516	442	387	310	258	221	194	172
IDKT 120-10 (25 M)	VC	3.0	3.16	758	632	542	474	379	316	271	237	211
	C	4.0	3.65	876	730	626	548	438	365	313	274	243
	C	5.0	4.08	979	816	699	612	490	408	350	306	272
	C	6.0	4.47	1,073	894	766	671	536	447	383	335	298
	UC	1.0	2.27	545	454	389	341	272	227	195	170	151
	EC	1.5	2.79	670	558	478	419	335	279	239	209	186
IDKT 120-10 (25 M)	VC	2.0	3.22	773	644	552	483	386	322	276	242	215
	VC	3.0	3.94	946	788	675	591	473	394	338	296	263
	C	4.0	4.55	1,092	910	780	683	546	455	390	341	303
	C	5.0	5.09	1,222	1,018	873	764	611	509	436	382	339
	C	6.0	5.57	1,337	1,114	955	836	668	557	477	418	371

ISO 25358 classification according to droplet sizes:

VF	Very fine
F	Fine
M	Medium
C	Coarse
VC	Very coarse
EC	Extremely coarse
UC	Ultra coarse

Subject to modifications.

- Operating pressure at the nozzle (measured with diaphragm valve)
- The stated liter-per-hectare rates apply to water
- Verify the table values by gauging the flow rates prior to every spraying season
- Pay attention to uniform nozzle adjustment



Recommendation

Optimum protection of IDKT nozzles thanks to long design of MultiCap (see Page 124).

Available fully assembled with IDKT nozzles.

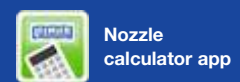

The apps for Lechler agricultural nozzles make selection and use of the optimum nozzle even easier. Find out more here: www.lechler.com/de-en/service/apps



Ordering example:	Series	+ Nozzle size	+ Material	= Order No.
	IDKT	+ 04	+ (POM)	= IDKT 04
	IDKT	+ 04	+ C (Ceramic)	= IDKT 04 C
	MultiCap IDKT	+ 04	+ (POM)	= MultiCap IDKT 04

Twin flat spray nozzles DF

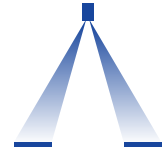

Crop production / **Ground care**

Dimensions in mm.

- Standard twin flat spray nozzle for fine-droplet application

Advantages

- Symmetrical twin flat spray jet 30°/30°
- Good wetting even on vertical target surfaces
- Low risk of clogging due to central supply flow cross-section
- Suitable for PWM

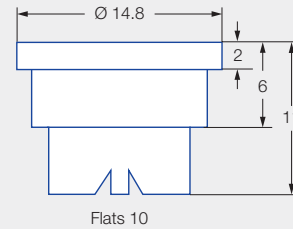

Series DF

Application:



Plant protection products



Edge application
Can be combined with border nozzle OC

Technical data:



Nozzle sizes
02-06



Spray angle
120°



Material
Stainless steel



Pressure ranges
2-3-5 bar



Recommended strainers



- 80 M 02-03
- 60 M 04-06



Droplet sizes
Medium - very fine



Width across flats
10 mm

			[l/min]	[l/ha] 									
				4.0 km/h	5.0 km/h	5.5 km/h	6.0 km/h	6.5 km/h	7.0 km/h	7.5 km/h	8.0 km/h	10.0 km/h	12.0 km/h
DF 120-02 (80 M)	2.0	0.65	195	156	142	130	120	111	104	98	78	65	
	2.5	0.73	219	175	159	146	135	125	117	110	88	73	
	3.0	0.80	240	192	175	160	148	137	128	120	96	80	
	3.5	0.86	258	206	188	172	159	147	138	129	103	86	
	4.0	0.92	276	221	201	184	170	158	147	138	110	92	
	4.5	0.98	294	235	214	196	181	168	157	147	118	98	
DF 120-03 (80 M)	2.0	0.97	291	233	212	194	179	166	155	146	116	97	
	2.5	1.08	324	259	236	216	199	185	173	162	130	108	
	3.0	1.19	357	286	260	238	220	204	190	179	143	119	
	3.5	1.28	384	307	279	256	236	219	205	192	154	128	
	4.0	1.37	411	329	299	274	253	235	219	206	164	137	
	4.5	1.46	438	350	319	292	270	250	234	219	175	146	
DF 120-04 (60 M)	2.0	1.29	387	310	281	258	238	221	206	194	155	129	
	2.5	1.44	432	346	314	288	266	247	230	216	173	144	
	3.0	1.58	474	379	345	316	292	271	253	237	190	158	
	3.5	1.71	513	410	373	342	316	293	274	257	205	171	
	4.0	1.82	546	437	397	364	336	312	291	273	218	182	
	4.5	1.94	582	466	423	388	358	333	310	291	233	194	
DF 120-05 (60 M)	2.0	1.61	483	386	351	322	297	276	258	242	193	161	
	2.5	1.80	540	432	393	360	332	309	288	270	216	180	
	3.0	1.97	591	473	430	394	364	338	315	296	236	197	
	3.5	2.13	639	511	465	426	393	365	341	320	256	213	
	4.0	2.28	684	547	497	456	421	391	365	342	274	228	
	4.5	2.42	726	581	528	484	447	415	387	363	290	242	
DF 120-06 (60 M)	2.0	1.93	579	463	421	386	356	331	309	290	232	193	
	2.5	2.16	648	518	471	432	399	370	346	324	259	216	
	3.0	2.36	708	566	515	472	436	405	378	354	283	236	
	3.5	2.55	765	612	556	510	471	437	408	383	306	255	
	4.0	2.73	819	655	596	546	504	468	437	410	328	273	
	4.5	2.90	870	696	633	580	535	497	464	435	348	290	
	5.0	3.05	915	732	665	610	563	523	488	458	366	305	

- Operating pressure at the nozzle (measured with diaphragm valve)
- The stated liter-per-hectare rates apply to water
- Verify the table values by gauging the flow rates prior to every spraying season
- Pay attention to uniform nozzle adjustment

Ordering example: Series DF + Nozzle size 02 + Material S (stainless steel) = Order No. DF 02 S



TwinSprayCap

Bayonet combination cap for air-injector nozzles and flat spray nozzles

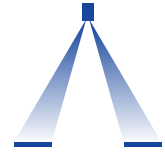

Crop production

Ground care

- Bayonet combination cap (incl. gasket) with symmetrical twin flat spray jet 30°/30°
- Flexible nozzle equipment possible

Advantages

- Variable nozzle selection also of different nozzle types and sizes
- Enhanced deposition through combination of low-drift injector nozzles and standard flat spray nozzles
- MULTIJET and Hardi suitable for flat spray nozzles AF 8 and 10
- MULTIJET with round hole bore 12.8 mm suitable for hollow cone and flat spray nozzles
- Simple nozzle assembly without tools through plug-in clip system
- Assembly via MULTIJET and Hardi bayonet system or intermediate and extension adapters (see Page 125)



Application:



Plant protection products



Spray frame



Dropleg^{UL}



Golf course



Greenhouse

Technical data:



Width across flats

8 and 10 mm and round hole



MULTIJET
Order No.: 092.163.56.00



MULTIJET with round hole bore
e.g. for use on Dropleg^{UL} (see Page 123)
Order No.: 092.163.56.10



Hardi
Order No.: 092.163.56.01

Nozzle adjustment template for Dropleg^{UL} applications

The template can be used to adjust the correct nozzle angle when using the TwinSprayCap with round hole bore. When using flood nozzles, this can be done with a screwdriver to align the slot on the front of the flood nozzle with the line on the template. In the case of flat spray nozzles, alignment is performed with an open-end wrench AF 8/10. If the key surfaces of the nozzle are parallel to the lines on the template, this also corresponds to the flat spray jet alignment. The template contains two adjustment examples (front/rear side) with lateral alignment and 180° alignment up/down.

Front side

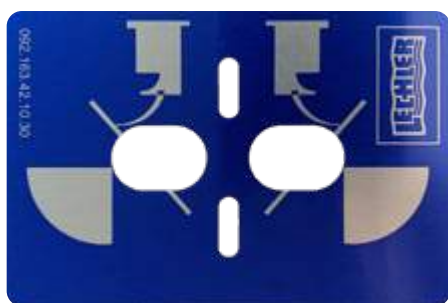

Rear side

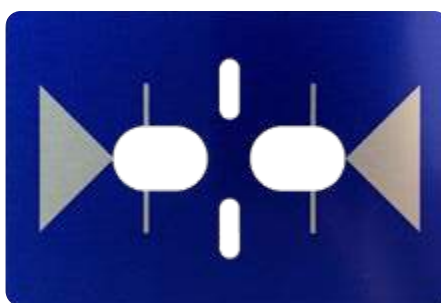

Adjustment template
Order No. 092.163.42.10.30

Note on assembly

Wet gasket with water before fitting on the nozzle holder.

Information for determination of nozzle size

Selection of the nozzle size by l/ha spray tables – the correct nozzle size corresponds to the determined nozzle size divided by 2.

Example

Two -02 corresponds to the l/ha rate of -04; alternatively equipment with one -015 and one -025 also corresponds to the l/ha rate of -04.

Note

You can find further information on Dropleg^{UL} and accessories on Page 123.



Nozzle calculator app

The apps for Lechler agricultural nozzles make selection and use of the optimum nozzle even easier. Find out more here:
www.lechler.com/de-en/service/apps



Ordering	Series	= Order No.
example:	TwinSprayCap (incl. gasket no. 095.015.6C.10.13.0) System MULTIJET	= 092.163.56.00
	TwinSprayCap (incl. gasket no. 095.015.6C.10.13.0) System MULTIJET, round hole bore	= 092.163.56.10
	TwinSprayCap (incl. gasket no. 095.015.73.01.60.0) System Hardi	= 092.163.56.01
	Adjustment template for TwinSprayCap round hole bore	= 092.163.42.10.30

Flood nozzles FT 140/FT 90

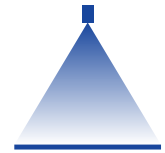

Crop production

Ground care

Dimensions in mm.

- Blockage-resistant flat spray nozzle
- Compact design

Advantages

- Large, round flow cross-sections
- Rinsing free of impact surface in the event of soiling
- Jet build-up already from 1 bar
- Clogging-resistant nozzle for gentle application of nematodes and compost tea
- FT 90 with particularly low drift thanks to pre-atomizer
- 90% drift reduction for FT 90-03 in Dropleg^{UL} and for band spraying
- Suitable for PWM

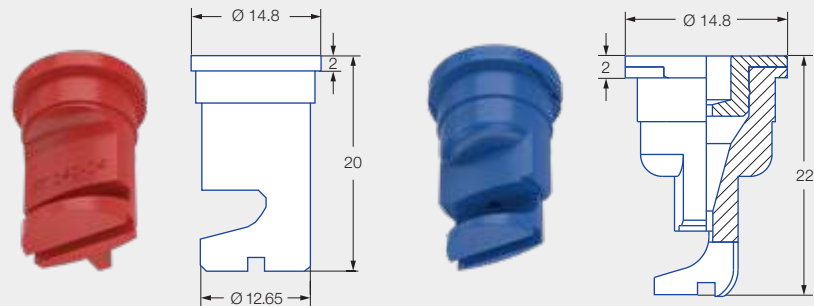

FT 140

FT 90

Series FT



Pre-atomizer can be removed without tools

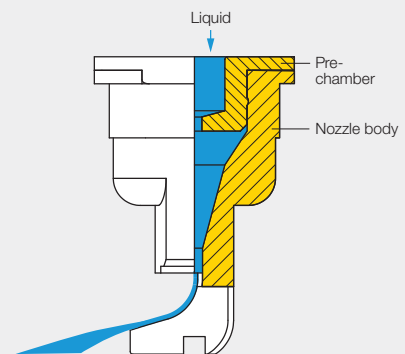

JKI approval as loss-reducing:
90/75/50 %

G 2086



Current list at:
www.lechler.com/de-en/service/loss-reducing

Application:



Plant protection products and growth regulators



Backpack sprayer



Dropleg^{UL}



Greenhouse



Band spraying
FT 90

Technical data:



Nozzle sizes
01–20



Spray angles
90°, 140°



Materials
POM, stainless steel, brass



Pressure ranges
• FT 90: 1–3–6 bar
• FT 140: 1–2–3 bar



Recommended strainers
• 80 M 01
• 60 M 015–04
• 25 M 05–20





Droplet sizes
• FT 90:
Extremely coarse – fine
• FT 140:
Very coarse – fine



Union nut
Ø 12.65 mm



Spray heights
• FT 90°:
60–75–90 cm
• FT 140°:
40 cm

	ISO 25358	[l/min]	[l/ha] 								[l/ha] 							
			FT 90		FT 140		6.0 km/h	8.0 km/h	10.0 km/h	12.0 km/h	14.0 km/h	16.0 km/h	6.0 km/h	8.0 km/h	10.0 km/h	12.0 km/h	14.0 km/h	16.0 km/h
			FT 90	FT 140														
FT 90-01 140-01 (80 M)	EC		1.0	0.23	46	35	28	23	20	17	31	23	18	15	13	12		
	C	VC	2.0	0.32	64	48	38	32	27	24	43	32	26	21	18	16		
	M	C	3.0	0.39	78	59	47	39	33	29	52	39	31	26	22	20		
	M		4.0	0.45	90	68	54	45	39	34	60	45	36	30	26	23		
FT 90-015 140-015 (60 M)	EC	VC	1.0	0.34	68	51	41	34	29	26	45	34	27	23	19	17		
	M	M	2.0	0.48	96	72	58	48	41	36	64	48	38	32	27	24		
	M	F	3.0	0.59	118	89	71	59	51	44	79	59	47	39	34	30		
	M		4.0	0.68	136	102	82	68	58	51	91	68	54	45	39	34		
FT 90-02 140-02 (60 M)	VC	VC	1.0	0.46	92	69	55	46	39	35	61	46	37	31	26	23		
	M	F	2.0	0.65	130	98	78	65	56	49	87	65	52	43	37	33		
	M	F	3.0	0.80	160	120	96	80	69	60	107	80	64	53	46	40		
	M		4.0	0.92	184	138	110	92	79	69	123	92	74	61	53	46		
FT 90-03 140-03 (60 M)	VC	C	1.0	0.69	138	104	83	69	59	52	92	69	55	46	39	35		
	M	F	2.0	0.97	194	146	116	97	83	73	129	97	78	65	55	49		
	M	F	3.0	1.19	238	179	143	119	102	89	159	119	95	79	68	60		
	M		4.0	1.37	274	206	164	137	117	103	183	137	110	91	78	69		
FT 90-04 140-04 (60 M)	VC	M	1.0	0.91	182	137	109	91	78	68	121	91	73	61	52	46		
	C	F	2.0	1.29	258	194	155	129	111	97	172	129	103	86	74	65		
	M	M	3.0	1.58	316	237	190	158	135	119	211	158	126	105	90	79		
	M		4.0	1.82	364	273	218	182	156	137	243	182	146	121	104	91		
FT 90-05 140-05 (25 M)	VC	M	1.0	1.14	228	171	137	114	98	86	152	114	91	76	65	57		
	C	F	2.0	1.61	322	242	193	161	138	121	215	161	129	107	92	81		
	C	M	3.0	1.97	394	296	236	197	169	148	263	197	158	131	113	99		
	M		4.0	2.27	454	341	272	227	195	170	303	227	182	151	130	114		
FT 140-06 (25 M)		M	1.0	1.36	272	204	163	136	117	102	181	136	109	91	78	68		
		M	2.0	1.93	386	290	232	193	165	145	257	193	154	129	110	97		
		M	3.0	2.36	472	354	283	236	202	177	315	236	189	157	135	118		
FT 140-08 (25 M)		M	1.0	1.82	364	273	218	182	156	137	243	182	146	121	104	91		
		M	2.0	2.58	516	387	310	258	221	194	344	258	206	172	147	129		
		M	3.0	3.16	632	474	379	316	271	237	421	316	253	211	181	158		
FT 140-10 (25 M)		M	1.0	2.27	454	341	272	227	195	170	303	227	182	151	130	114		
		M	2.0	3.22	644	483	386	322	276	242	429	322	258	215	184	161		
		M	3.0	3.94	788	591	473	394	338	296	525	394	315	263	225	197		
FT 140-15 (25 M)		C	1.0	3.41	682	512	409	341	292	256	455	341	273	227	195	171		
		C	2.0	4.83	966	725	580	483	414	362	644	483	386	322	276	242		
		C	3.0	5.91	1,182	887	709	591	507	443	788	591	473	394	338	296		
FT 140-20 (25 M)		C	1.0	4.55	910	683	546	455	390	341	607	455	364	303	260	228		
		C	2.0	6.43	1,286	965	772	643	551	482	857	643	514	429	367	322		
		C	3.0	7.88	1,576	1,182	946	788	675	591	1,051	788	630	525	450	394		

ISO 25358 classification according to droplet sizes:

- VF Very fine
- F Fine
- M Medium
- C Coarse
- VC Very coarse
- EC Extremely coarse
- UC Ultra coarse

Subject to modifications.

- Operating pressure at the nozzle (measured with diaphragm valve)
- The stated liter-per-hectare rates apply to water
- Verify the table values by gauging the flow rates prior to every spraying season
- Pay attention to uniform nozzle adjustment

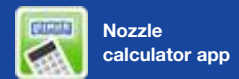

The apps for Lechler agricultural nozzles make selection and use of the optimum nozzle even easier. Find out more here: www.lechler.com/de-en/service/apps



Ordering example:	Series	+ Spray angle	+ Nozzle size	+ Material	= Order No.
	FT	+ 90°	+ 01	+ (POM)	= FT 90-01
	FT	+ 140°	+ 01	+ (POM)	= FT 140-01
	FT	+ 140°	+ 01	+ M (brass)	= FT 140-01 M
	FT	+ 140°	+ 01	+ S (stainless steel)	= FT 140-01 S

Air-injector flat spray nozzles ID-90

ID3

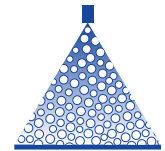

Crop production

- Air-aspirating flat spray nozzle
- Extremely low drift over the entire pressure range

Advantages

- In new, optimized ID3 design
- Extended pressure range from 2 to 20 bar
- Exceptionally low-drift also in the high pressure range up to 20 bar
- Large, clogging-resistant flow cross-sections
- Significantly improved crop penetration
- Suitable for PWM

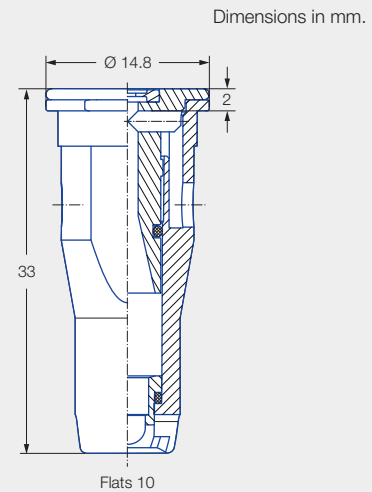

Series ID-90



Injector can be removed
without tools

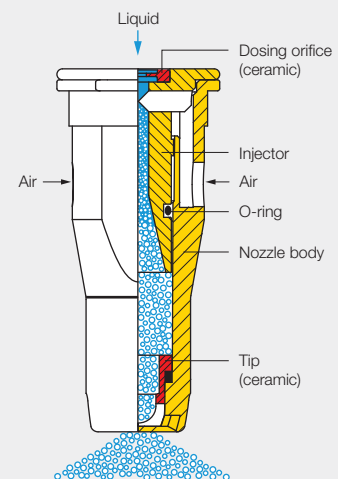

Application:

Plant protection products and growth regulators

Plant protection in viticulture, orchard and specialty crops

Sensor control

Vertical boom

Spray frame

Technical data:

Nozzle sizes
01–06

Spray angle
90°

Material
Ceramic

Pressure ranges
2–8–15–20 bar

Recommended strainers

- 60 M 01–04
- 25 M 05–06

Droplet sizes
Ultra coarse – medium

Width across flats
10 mm

Good to know

You can find detailed information in our brochure "Viticulture, orchard and specialty crops" and at www.lechler-agri.com



			[l/min]																	
			2.0	3.0	4.0	5.0	6.0	7.0	8.0	9.0	10.0	11.0	12.0	13.0	14.0	15.0	16.0	17.0	19.0	20.0
	ID-90-01	60 M	0.32	0.39	0.45	0.51	0.55	0.60	0.64	0.68	0.72	0.75	0.78	0.82	0.85	0.88	0.91	0.93	0.99	1.01
	ID-90-015	60 M	0.48	0.59	0.68	0.76	0.83	0.90	0.96	1.02	1.07	1.13	1.18	1.22	1.27	1.31	1.36	1.40	1.48	1.52
	ID-90-02	60 M	0.65	0.80	0.92	1.03	1.13	1.22	1.30	1.38	1.45	1.53	1.60	1.67	1.73	1.79	1.85	1.90	2.01	2.07
	ID-90-025	60 M	0.81	0.99	1.15	1.28	1.40	1.52	1.62	1.71	1.81	1.90	1.98	2.06	2.14	2.21	2.29	2.36	2.49	2.56
	ID-90-03	60 M	0.97	1.19	1.37	1.53	1.68	1.81	1.94	2.06	2.17	2.28	2.38	2.48	2.57	2.66	2.75	2.83	2.99	3.07
	ID-90-04	60 M	1.29	1.58	1.82	2.04	2.23	2.41	2.58	2.74	2.88	3.03	3.16	3.29	3.41	3.53	3.65	3.76	3.98	4.08
	ID-90-05	25 M	1.61	1.97	2.28	2.55	2.79	3.01	3.22	3.42	3.60	3.77	3.94	4.10	4.26	4.41	4.55	4.69	4.96	5.09
	ID-90-06	25 M	1.93	2.36	2.73	3.05	3.34	3.61	3.86	4.09	4.32	4.52	4.72	4.91	5.10	5.28	5.45	5.62	5.94	6.09

- The stated l/ha values apply to water
- Check the nozzles by gauging the flow rates prior to every spraying season
- Pressure measured at the nozzle

Assembly

Alignment of the flat jet spray jet of the ID nozzles parallel to the air flow of the sprayer, use open-end wrench AF 10.

Nozzle assembly:

- With cup strainer, gasket 3.0 mm (Order No. **065.240.73.01**)
- Without cup strainer, gasket 5.0 mm (Order No. **095.015.6C.07.10**)

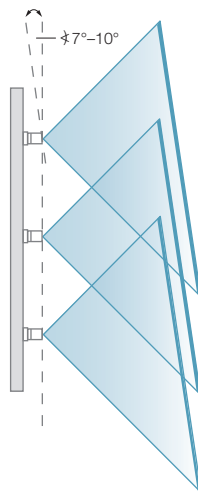

Nozzle calculator app

The apps for Lechler agricultural nozzles make selection and use of the optimum nozzle even easier. Find out more here: www.lechler.com/de-en/service/apps



Ordering Series + Nozzle size + Material = Order No.
example: ID-90 + 02 + C (Ceramic) = ID-90-02 C

Compact air-injector flat spray nozzles

IDK 90

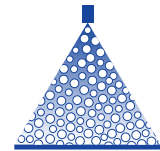

Crop production

- Air-aspirating flat spray nozzle
- Extremely low drift over the entire pressure range

Advantages

- 99/95/90/75/50 % drift reduction for: IDK 90-0067 C to -02 C
- Only 7 mm longer than TR hollow cone nozzle
- Large, clogging-resistant cross-sections
- Breakage-resistant nozzle housing with beveled edges and reinforced walls
- Suitable for PWM



IDK 90-01 C

75 % drift reduction in accordance with MABO dosage

Series IDK 90

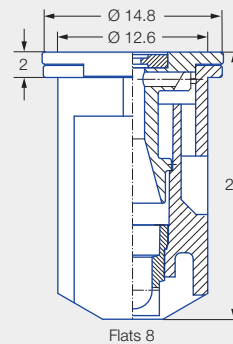

Dimensions in mm.



JKI approval as loss-reducing: 99/95/90/75/50 %

G 1834, G 1835, G 1886, G 1941, G 2052, G 2053



Current list at: www.lechler.com/de-en/service/loss-reducing



Injector can be removed without tools

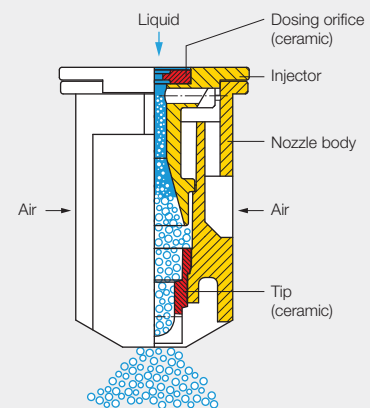

Application:



Plant protection products and growth regulators



Plant protection in viticulture, orchard and specialty crops



Sensor control



Vertical boom



Spray frame

Technical data:



Nozzle sizes
0067-06



Spray angle
90°



Material
Ceramic



Pressure ranges
2-8-15-20 bar



Recommended strainers

- 60 M 0067-04
- 25 M 05-06



Droplet sizes
Extremely coarse - fine



Width across flats
8 mm

Good to know

You can find detailed information in our brochure "Viticulture, orchard and specialty crops" and at www.lechler-agri.com



		[l/min]																	
		2.0	3.0	4.0	5.0	6.0	7.0	8.0	9.0	10.0	11.0	12.0	13.0	14.0	15.0	16.0	17.0	19.0	20.0
	IDK 90-0067 60 M	0.22	0.27	0.31	0.35	0.38	0.41	0.44	0.47	0.49	0.52	0.54	0.56	0.58	0.60	0.62	0.64	0.68	0.70
	IDK 90-01 60 M	0.32	0.39	0.45	0.51	0.55	0.60	0.64	0.68	0.72	0.75	0.78	0.82	0.85	0.88	0.91	0.93	0.99	1.01
	IDK 90-015 60 M	0.48	0.59	0.68	0.76	0.83	0.90	0.96	1.02	1.07	1.13	1.18	1.22	1.27	1.31	1.36	1.40	1.48	1.52
	IDK 90-02 60 M	0.65	0.80	0.92	1.03	1.13	1.22	1.30	1.38	1.45	1.53	1.60	1.67	1.73	1.79	1.85	1.90	2.01	2.07
	IDK 90-025 60 M	0.81	0.99	1.15	1.28	1.40	1.52	1.62	1.71	1.81	1.90	1.98	2.06	2.14	2.21	2.29	2.36	2.49	2.56
	IDK 90-03 60 M	0.97	1.19	1.37	1.53	1.68	1.81	1.94	2.06	2.17	2.28	2.38	2.48	2.57	2.66	2.75	2.83	2.99	3.07
	IDK 90-04 60 M	1.29	1.58	1.82	2.04	2.23	2.41	2.58	2.74	2.88	3.03	3.16	3.29	3.41	3.53	3.65	3.76	3.98	4.08
	IDK 90-05 25 M	1.61	1.97	2.28	2.55	2.79	3.01	3.22	3.42	3.60	3.77	3.94	4.10	4.26	4.41	4.55	4.69	4.96	5.09
	IDK 90-06 25 M	1.93	2.36	2.73	3.05	3.34	3.61	3.86	4.09	4.32	4.52	4.72	4.91	5.10	5.28	5.45	5.62	5.94	6.09

- The stated l/ha values apply to water
- Check the nozzles by gauging the flow rates prior to every spraying season
- Pressure measured at the nozzle

Assembly

Alignment of the flat jet spray jet of the IDK nozzles parallel to the air flow of the sprayer, use open-end wrench AF 8.

Nozzle assembly:

- With cup strainer, gasket 3.0 mm (Order No. **065.240.73.01**)
- Without cup strainer, gasket 5.0 mm (Order No. **095.015.6C.07.10**)

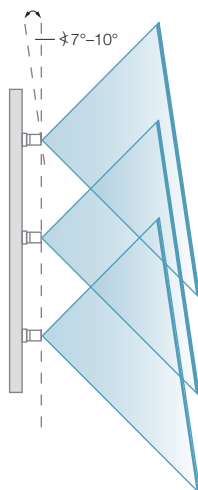

Nozzle calculator app

The apps for Lechler agricultural nozzles make selection and use of the optimum nozzle even easier. Find out more here: www.lechler.com/de-en/service/apps



Ordering Series + Nozzle size + Material = Order No.
example: IDK 90 + 02 + C (Ceramic) = IDK 90-02 C

Anti-drift flat spray nozzles AD 90

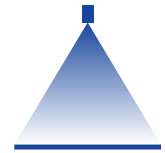

Crop production

Dimensions in mm.

- Low-drift flat spray nozzle

Advantages

- 99/95/90/75/50 % drift reduction for: AD 90-01 C to -04 C
- Fine droplets at higher pressure
- Pre-atomizer can be removed without tools
- NEW** • Pre-atomizer has flush contact with twist lock
- Ideal for cramped installation conditions (4 mm shorter than TR hollow cone nozzle) thanks to compact design
- Ideal for sensor control thanks to very fast jet build-up and reduction
- Suitable for PWM



Series AD 90

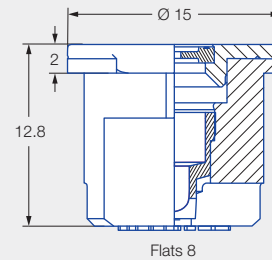

Pre-atomizer can be removed without tools

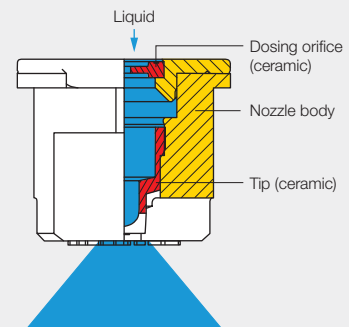

JKI approval as loss-reducing:
99/95/90/75/50 %

G 1666, G 1667, G 1668, G 2041, G 2042



Current list at:
www.lechler.com/de-en/service/loss-reducing

Application:



Plant protection products and growth regulators



Plant protection in viticulture, orchard and specialty crops



Sensor control



Vertical boom

Technical data:



Nozzle sizes
0067-04



Spray angle
90°



Material
Ceramic



Pressure ranges
2-8-15-20 bar



Recommended strainers
60 M 0067-04



Droplet sizes
Coarse - fine





Width across flats
8 mm

Good to know

You can find detailed information in our brochure "Viticulture, orchard and specialty crops" and at www.lechler-agri.com



		[l/min]																	
		2.0	3.0	4.0	5.0	6.0	7.0	8.0	9.0	10.0	11.0	12.0	13.0	14.0	15.0	16.0	17.0	19.0	20.0
																			
AD 90-0067	60 M	0.22	0.27	0.31	0.35	0.38	0.41	0.44	0.47	0.49	0.52	0.54	0.56	0.58	0.60	0.62	0.64	0.68	0.70
AD 90-01	60 M	0.32	0.39	0.45	0.51	0.55	0.60	0.64	0.68	0.72	0.75	0.78	0.82	0.85	0.88	0.91	0.93	0.99	1.01
AD 90-015	60 M	0.48	0.59	0.68	0.76	0.83	0.90	0.96	1.02	1.07	1.13	1.18	1.22	1.27	1.31	1.36	1.40	1.48	1.52
AD 90-02	60 M	0.65	0.80	0.92	1.03	1.13	1.22	1.30	1.38	1.45	1.53	1.60	1.67	1.73	1.79	1.85	1.90	2.01	2.07
AD 90-025	60 M	0.81	0.99	1.15	1.28	1.40	1.52	1.62	1.71	1.81	1.90	1.98	2.06	2.14	2.21	2.29	2.36	2.49	2.56
AD 90-03	60 M	0.97	1.19	1.37	1.53	1.68	1.81	1.94	2.06	2.17	2.28	2.38	2.48	2.57	2.66	2.75	2.83	2.99	3.07
AD 90-04	60 M	1.29	1.58	1.82	2.04	2.23	2.41	2.58	2.74	2.88	3.03	3.16	3.29	3.41	3.53	3.65	3.76	3.98	4.08

- The stated l/ha values apply to water
- Check the nozzles by gauging the flow rates prior to every spraying season
- Pressure measured at the nozzle

Assembly

Alignment of the flat jet spray jet of the AD nozzles parallel to the air flow of the sprayer, use open-end wrench AF 8.

Nozzle assembly:

- With cup strainer, gasket 3.0 mm (Order No. **065.240.73.01**)
- Without cup strainer, gasket 5.0 mm (Order No. **095.015.6C.07.10**)

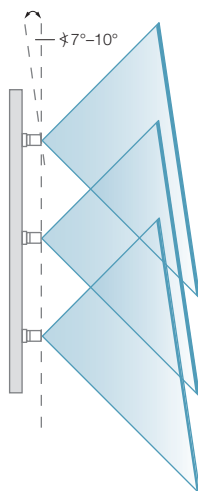

Nozzle calculator app

The apps for Lechler agricultural nozzles make selection and use of the optimum nozzle even easier. Find out more here: www.lechler.com/de-en/service/apps



Ordering example: Series AD 90 + Nozzle size 02 + Material C (Ceramic) = Order No. AD 90-02 C

Hollow cone nozzles

TR 80/TR 60



Crop production / **Ground care**

Dimensions in mm.

- Fine-droplet hollow cone nozzle with 60° and 80° spray angle

TR 80 advantages

- Optimized, narrow droplet spectrum
- Fine droplets ensure high coverage
- Nozzle insert secured to prevent it falling out by means of snap closure
- Resistant to clogging due to round hole bore
- Suitable for PWM



Series TR 80

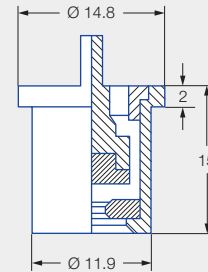

NEW TR 60 advantages

- Improved image of air flow due to spray angle of 60°
- Simple handling also with protective gloves
- Quick insert removal without tools for cleaning
- Increased stability thanks to reinforced housing
- Even more uniform spray pattern thanks to new swirl insert design
- Increased wear resistance
- Available with 2 mm and 5 mm nozzle collar
- Suitable for PWM

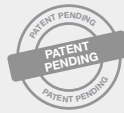

Series TR 60

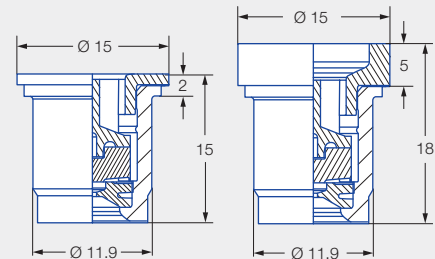

G 1496, G 1497, G 1498



Current list at:
www.lechler.com/de-en/service/loss-reducing

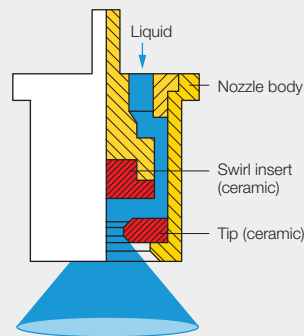

TR 80

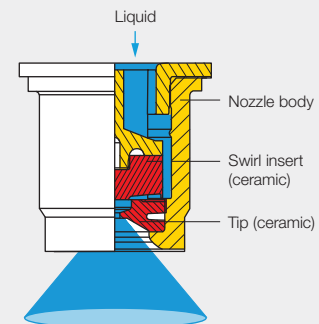

TR 60

Application:



Plant protection products and growth regulators



Plant protection in viticulture, orchard and specialty crops



Backpack sprayer



Greenhouse

Technical data:



Nozzle sizes
005–05



Spray angles
60°, 80°



Material
Ceramic



Pressure ranges

- TR 80:
3–8–20 bar
- TR 60:
2–8–20 bar



Recommended strainers



- 60 M 005–04
- 25 M 05



Droplet sizes
Fine – very fine



Union nut
Ø 11.9 mm

		[l/min]																			
																					
		2.0	3.0	4.0	5.0	6.0	7.0	8.0	9.0	10.0	11.0	12.0	13.0	14.0	15.0	16.0	17.0	19.0	20.0		
		TR 60-005 80-005	60 M	0.16	0.20	0.23	0.25	0.28	0.30	0.32	0.34	0.36	0.38	0.39	0.41	0.42	0.44	0.45	0.47	0.49	0.51
		TR 60-0067 80-0067	60 M	0.22	0.27	0.31	0.35	0.38	0.41	0.44	0.47	0.49	0.52	0.54	0.56	0.58	0.60	0.62	0.64	0.68	0.70
		TR 60-01 80-01	60 M	0.32	0.39	0.45	0.51	0.55	0.60	0.64	0.68	0.72	0.75	0.78	0.82	0.85	0.88	0.91	0.93	0.99	1.01
		TR 60-015 80-015	60 M	0.48	0.59	0.68	0.76	0.83	0.90	0.96	1.02	1.07	1.13	1.18	1.22	1.27	1.31	1.36	1.40	1.48	1.52
		TR 60-02 80-02	60 M	0.65	0.80	0.92	1.03	1.13	1.22	1.30	1.38	1.45	1.53	1.60	1.67	1.73	1.79	1.85	1.90	2.01	2.07
NEW		TR 60-025 80-025	60 M	0.81	0.99	1.15	1.28	1.40	1.52	1.62	1.71	1.81	1.90	1.98	2.06	2.14	2.21	2.29	2.36	2.49	2.56
		TR 60-03 80-03	60 M	0.97	1.19	1.37	1.53	1.68	1.81	1.94	2.06	2.17	2.28	2.38	2.48	2.57	2.66	2.75	2.83	2.99	3.07
		TR 60-04 80-04	60 M	1.29	1.58	1.82	2.04	2.23	2.41	2.58	2.74	2.88	3.03	3.16	3.29	3.41	3.53	3.65	3.76	3.98	4.08
		TR 60-05 80-05	25 M	1.61	1.97	2.28	2.55	2.79	3.01	3.22	3.42	3.60	3.77	3.94	4.10	4.26	4.41	4.55	4.69	4.96	5.09

- Operating pressure at the nozzle (measured with diaphragm valve)
- The stated liter-per-hectare rates apply to water
- Verify the table values by gauging the flow rates prior to every spraying season
- Pay attention to uniform nozzle adjustment

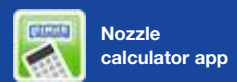

The apps for Lechler agricultural nozzles make selection and use of the optimum nozzle even easier. Find out more here:
www.lechler.com/de-en/service/apps



Note

TR 60 with 5 mm collar does not require a gasket for installation with/without cup strainer.

Ordering example:	Series	+ Spray angle	+ Nozzle size	+ Material	+ Collar height	= Order No.
	TR	+ 80°	+ 005	+ C (Ceramic)	+ 2 mm	= TR 80-005 C 2 mm
	TR	+ 60°	+ 005	+ C (Ceramic)	+ 2 mm	= TR 60-005 C 2 mm
	TR	+ 60°	+ 005	+ C (Ceramic)	+ 5 mm	= TR 60-005 C 5 mm

➤ Air-injector hollow cone nozzles ITR 80

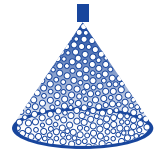

Crop production

Ground care

- Air-aspirating hollow cone nozzle
- Extremely low drift over the entire pressure range

Advantages

- 95/90/75/50 % drift reduction – ITR 80-01 C
- Exceptionally low-drift design
- Resistant to clogging due to round hole bore
- ISO color-coded
- Suitable for PWM

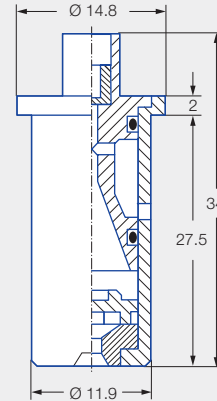

Dimensions in mm.



JKI approval as loss-reducing: 95/90/75/50 %

G 2023



Current list at:
www.lechler.com/de-en/service/loss-reducing

Series ITR 80



Injector can be removed without tools

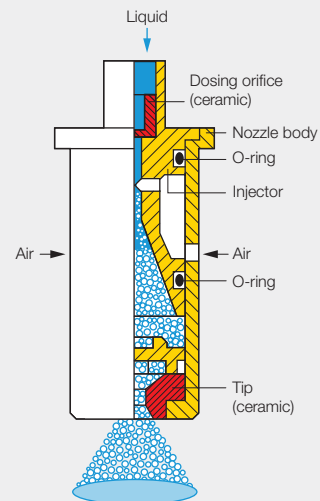

Application:



Plant protection products and growth regulators



Plant protection in viticulture, orchard and specialty crops

Technical data:



Nozzle sizes
01–02



Spray angle
80°



Material
Ceramic



Pressure ranges
3–10–30 bar



Recommended strainers
60 M 01–02









Droplet sizes
Extremely coarse – medium



Union nut
Ø 11.9 mm



		[l/min]																	
		  																	
		3.0	4.0	5.0	6.0	7.0	8.0	9.0	10.0	11.0	12.0	13.0	14.0	15.0	16.0	17.0	19.0	20.0	
	ITR 80-01	60 M	0.39	0.45	0.51	0.55	0.60	0.64	0.68	0.72	0.75	0.78	0.82	0.85	0.88	0.91	0.93	0.99	1.01
	ITR 80-015	60 M	0.59	0.68	0.76	0.83	0.90	0.96	1.02	1.07	1.13	1.18	1.22	1.27	1.31	1.36	1.40	1.48	1.52
	ITR 80-02	60 M	0.80	0.92	1.03	1.13	1.22	1.30	1.38	1.45	1.53	1.60	1.67	1.73	1.79	1.85	1.90	2.01	2.07

- The stated l/ha values apply to water
- Check the nozzles by gauging the flow rates prior to every spraying season
- Pressure measured at the nozzle



Nozzle calculator app

The apps for Lechler agricultural nozzles make selection and use of the optimum nozzle even easier. Find out more here: www.lechler.com/de-en/service/apps



Good to know

You can find detailed information in our brochure "Viticulture, orchard and specialty crops" and at www.lechler-agri.com



Ordering Series + Nozzle size + Material = Order No.
 example: ITR 80 + 02 + C (Ceramic) = ITR 80-02 C

Liquid fertilizer nozzle VR

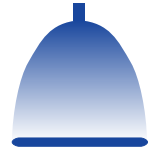

Crop production / **Ground care**

Dimensions in mm.

- Liquid fertilizer nozzle with variable flow rate
- Based on FD design with extremely uniform lateral distribution

Advantages

- Variable flow rate covers up to five ISO FD nozzle sizes
- Higher workrate without changing nozzles
- Flexible delivery with changing spraying speeds and in precise farming applications
- Gentle liquid fertilizer application thanks to extremely low spray impact
- Minimum risk of scorching due to ultra-coarse droplet spectrum
- Nozzle in cap with MULTIJET bayonet system incl. gasket and nozzle strainer 80 M



VR-M

VR-L

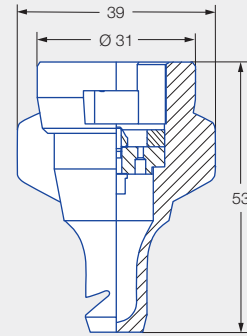

Series VR



Removable insert

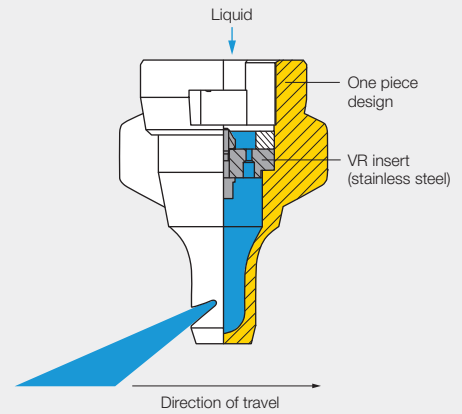

Application:



Liquid fertilizer delivery



Golf course

Technical data:



Nozzle sizes
VR-M and VR-L



Spray angle
130°



Materials
POM, stainless steel



Pressure ranges
2–8 bar



Recommended strainer
80 M



Droplet size
Ultra coarse



Spray heights
50–70 cm

Assembly



Note

The Lechler VR assembly aid facilitates aligned installation of the VR stainless steel insert including gasket.
Order number of VR assembly tool: **6VR.000.56.10.00.0**
(can be optionally ordered)



	[l/min]	UAN [l/ha] 									
		UAN 28	5.0 km/h	6.0 km/h	7.0 km/h	8.0 km/h	10.0 km/h	12.0 km/h	14.0 km/h	16.0 km/h	18.0 km/h
VR-M	2.0	1.03	247	206	177	154	124	103	88	77	69
	3.0	1.37	329	275	235	206	165	137	118	103	92
	4.0	1.71	410	341	293	256	205	171	146	128	114
	5.0	2.07	496	414	355	310	248	207	177	155	138
	6.0	2.50	600	500	428	375	300	250	214	187	167
	7.0	2.92	701	584	501	438	351	292	250	219	195
8.0	3.57	857	715	612	536	429	357	306	268	238	
VR-L	2.0	1.83	439	366	314	275	220	183	157	137	122
	3.0	2.71	650	542	465	407	325	271	232	203	181
	4.0	3.64	874	729	625	546	437	364	312	273	243
	5.0	4.52	1,086	905	775	678	543	452	388	339	302
	6.0	5.43	1,303	1,086	931	814	652	543	465	407	362
	7.0	6.40	1,535	1,280	1,097	960	768	640	548	480	427
8.0	7.29	1,749	1,457	1,249	1,093	874	729	625	546	486	

- Operating pressure at the nozzle (measured with diaphragm valve)
- The stated liter-per-hectare rates apply to UAN (28/1.28 kg/l)
- Verify the table values by gauging the flow rates prior to every spraying season
- Ensure uniform nozzle adjustment

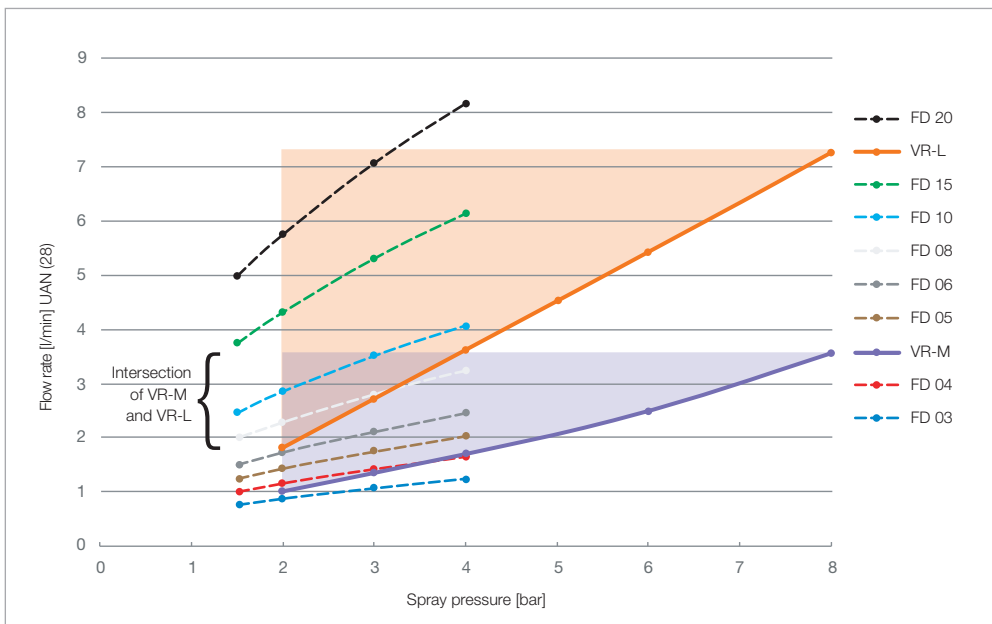

 **Nozzle calculator app**

The apps for Lechler agricultural nozzles make selection and use of the optimum nozzle even easier. Find out more here: www.lechler.com/de-en/service/apps

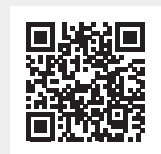

Recommendation
Use in flow-controlled boom sprayers.

Ordering example: Series VR + Nozzle size M = Order No. VR-M

Liquid fertilizer nozzles

FD



Crop production / Ground care

Dimensions in mm.

- Flat spray nozzle with horizontal spray pattern for uniform cross distribution

Advantages

- Gentle liquid fertilizer application thanks to extremely low spray impact
- Minimum risk of scorching due to extremely coarse droplet application
- No striping due to optimum cross distribution
- Nozzle in cap for standard bayonet connection system MULTIJET (incl. gasket)

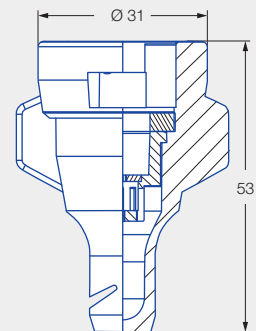
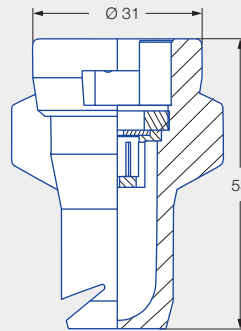

Series FD

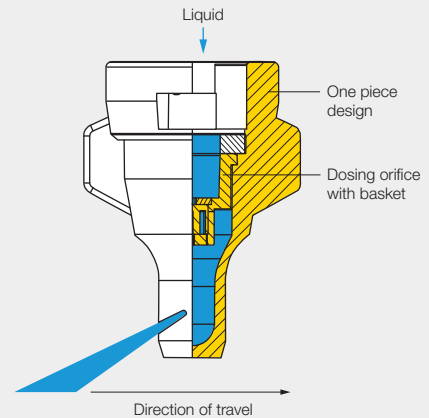

Pre-chamber can be removed without tools

Application:



Liquid fertilizer delivery



Greenhouse



Golf course

Technical data:



Nozzle sizes
02–20



Spray angle
130°



Material
POM



Pressure ranges
1.5–4 bar



Recommended strainers
• 60 M 02–04
• 25 M 05–20



Droplet size
Ultra coarse



Spray heights
50–70 cm

FD 04 – Cross distribution on patterator (with water)

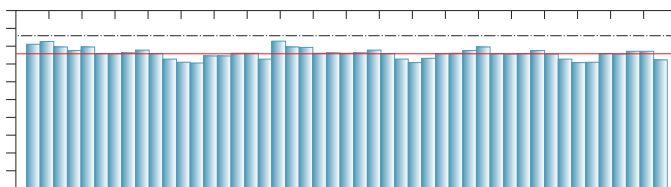

Pressure range: 2.0 bar
Spray height: 600 mm
Coefficient of variation: 3.4%

Good to know

You can find detailed information in our brochure "Application of liquid fertilizer" and at www.lechler-agri.com



	[l/min]	Water	UAN	UAN [l/ha]									
				5.0 km/h	6.0 km/h	7.0 km/h	8.0 km/h	10.0 km/h	12.0 km/h	14.0 km/h	16.0 km/h	18.0 km/h	
FD 02 (60 M)	1.5	0.57	0.50	121	101	86	76	60	50	43	38	34	
	2.0	0.65	0.57	138	115	98	86	69	57	49	43	38	
	3.0	0.80	0.71	170	141	121	106	85	71	61	53	47	
	4.0	0.92	0.81	195	163	139	122	98	81	70	61	54	
FD 03 (60 M)	1.5	0.85	0.75	180	150	129	113	90	75	64	56	50	
	2.0	0.98	0.87	208	173	148	130	104	87	74	65	58	
	3.0	1.20	1.06	255	212	182	159	127	106	91	80	71	
	4.0	1.39	1.23	295	246	211	184	147	123	105	92	82	
FD 04 (60 M)	1.5	1.13	1.00	240	200	171	150	120	100	86	75	67	
	2.0	1.31	1.16	278	232	198	174	139	116	99	87	77	
	3.0	1.60	1.41	339	283	242	212	170	141	121	106	94	
	4.0	1.85	1.64	392	327	280	245	196	164	140	123	109	
FD 05 (25 M)	1.5	1.41	1.25	299	249	214	187	149	125	107	93	83	
	2.0	1.63	1.44	346	288	247	216	173	144	123	108	96	
	3.0	2.00	1.77	424	354	303	265	212	177	152	133	118	
	4.0	2.31	2.04	490	408	350	306	245	204	175	153	136	
FD 06 (25 M)	1.5	1.70	1.50	361	301	258	225	180	150	129	113	100	
	2.0	1.96	1.73	416	346	297	260	208	173	148	130	115	
	3.0	2.40	2.12	509	424	364	318	255	212	182	159	141	
	4.0	2.77	2.45	588	490	420	367	294	245	210	184	163	
FD 08 (25 M)	1.5	2.26	2.00	479	400	342	300	240	200	171	150	133	
	2.0	2.61	2.31	554	461	395	346	277	231	198	173	154	
	3.0	3.20	2.83	679	566	485	424	339	283	242	212	189	
	4.0	3.70	3.27	785	654	561	491	392	327	280	245	218	
FD 10 (25 M)	1.5	2.83	2.50	600	500	429	375	300	250	214	188	167	
	2.0	3.27	2.89	694	578	495	434	347	289	248	217	193	
	3.0	4.00	3.54	849	707	606	530	424	354	303	265	236	
	4.0	4.62	4.08	980	817	700	613	490	408	350	306	272	
FD 15 (25 M)	1.5	4.24	3.75	899	750	642	562	450	375	321	281	250	
	2.0	4.90	4.33	1,039	866	742	650	520	433	371	325	289	
	3.0	6.00	5.30	1,273	1,061	909	795	636	530	455	398	354	
	4.0	6.93	6.13	1,470	1,225	1,050	919	735	613	525	459	408	
FD 20 (25 M)	1.5	5.66	5.00	1,201	1,001	858	750	600	500	429	375	334	
	2.0	6.53	5.77	1,385	1,154	989	866	693	577	495	433	385	
	3.0	8.00	7.07	1,697	1,414	1,212	1,061	849	707	606	530	471	
	4.0	9.24	8.17	1,960	1,633	1,400	1,225	980	817	700	613	544	

- Operating pressure at the nozzle (measured with diaphragm valve)
- The stated liter-per-hectare rates apply to UAN (28/1.28 kg/l)
- Verify the table values by gauging the flow rates prior to every spraying season
- Ensure uniform nozzle adjustment

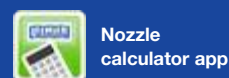

The apps for Lechler agricultural nozzles make selection and use of the optimum nozzle even easier. Find out more here: www.lechler.com/de-en/service/apps



Ordering Series + Nozzle size + Material = Order No.
example: FD + 06 + (POM) = FD 06

Intermediate and extension adapters



Intermediate adapter¹

Lechler TWISTLOC system
092.163.56.00.22.1
Extension: 22 mm



Rau system
092.163.56.00.21.0
Extension: 20 mm



Hardi system
092.163.56.00.20.1
Extension: 17 mm



Extension adapter and bayonet nipple¹

MULTIJET system
092.163.56.00.23.1
Extension: 32 mm



MULTIJET bayonet nipple
092.163.56.00.26.0
(see Page 133)

¹ Including gasket.

Liquid fertilizer border nozzle FB

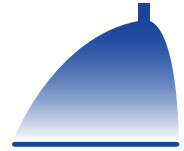

Crop production / Ground care

- Border nozzle compatible with FD series
- For right boom side

Advantages

- 100 % uniform cross distribution up to the field edge:
 - Prevents hunger stripes (often seen with fertilizer spreaders)
 - No yield and quality drop at the field edge
 - Economical and environmentally friendly application of liquid fertilizers to the field edge without over/under dosing and losses
 - Compliance with the German Fertilizer Regulation
- No overspraying of the field boundary
- Corresponding FB border nozzle in same ISO color as FD nozzle



FB 100-03

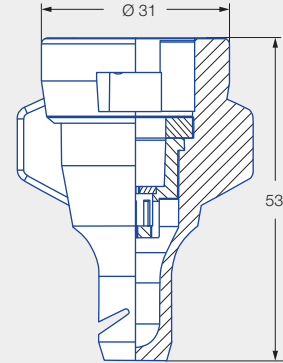

Dimensions in mm.

Series FB



Pre-chamber can be removed without tools

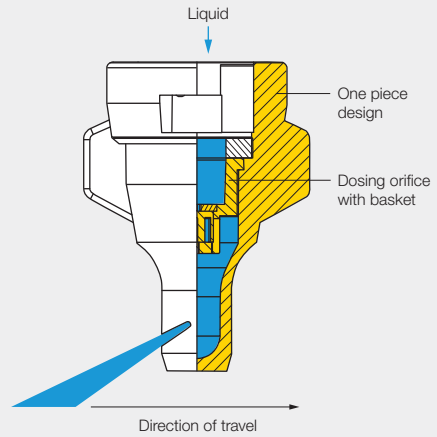

Application:



Border nozzle



Liquid fertilizer delivery



Greenhouse



Golf course

Technical data:



Nozzle sizes
02-08



Spray angle
100°



Material
POM



Pressure ranges
1.5-4 bar



Recommended strainers

- 60 M 02-04
- 25 M 05-08



Droplet size
Ultra coarse



Spray heights
50-70 cm

FD 04 – Cross distribution with border nozzle FB 100-04 on patternator (with water)

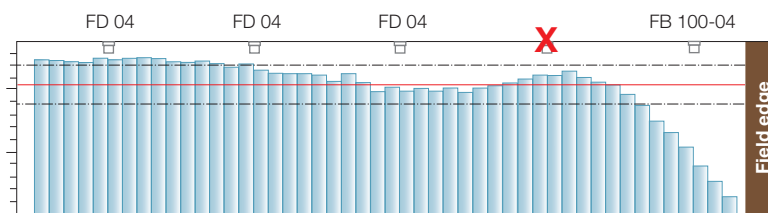

Pressure range: 3 bar
Spray height: 500 mm

Electric border nozzle kit

- Retrofittable, compact 3-way valve with integrated nozzle holders
- Can be electrically controlled from the driver's seat
- Ideally suited for FB nozzles in combination with FD nozzles or IS nozzles in combination with ID nozzles

Advantages

- Switchover without dismounting
- Fast switching in less than 1 second
- Minimum energy requirement, no power consumption during spraying
- All parts made of liquid fertilizer-resistant plastic or stainless steel

Order No. 065.290.00.00

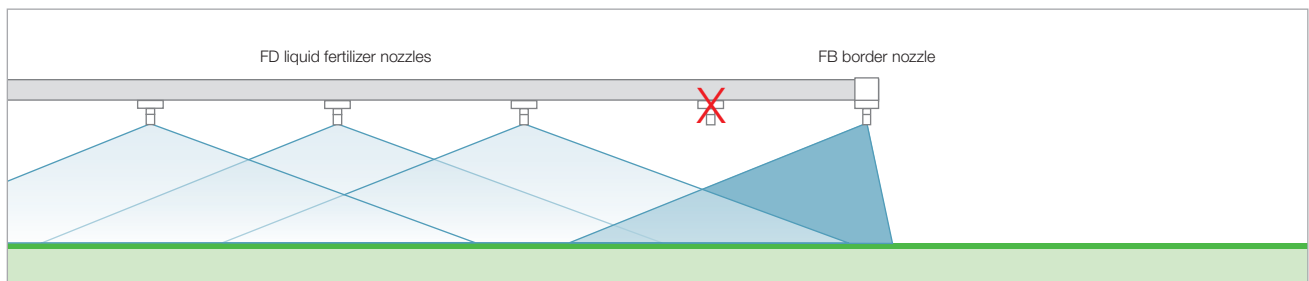

The spray range of the FB border nozzle is matched to FD nozzles.

Note

When treating the field edge, the FD nozzle in position 2 must be deactivated in order to avoid overspraying.

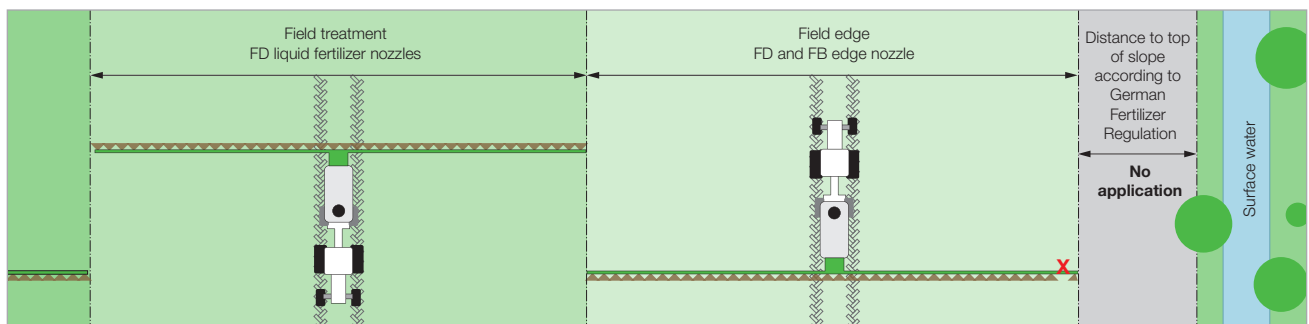

FB nozzles permit precise liquid fertilizer application up to the boundary of protected zones.

Pressure range: 3 bar
Spray height: 500 mm

Good to know

You can find detailed information in our assembly instruction "Electric Border Valve Kit" and at www.lechler.com/de-en/support



Ordering Series + Nozzle size + Material = Order No.
example: FB + 02 + (POM) = FB 02

Liquid fertilizer nozzles FS

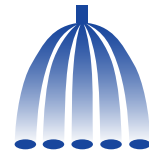

Crop production / Ground care

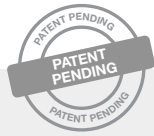

- Orifice nozzle with vertical spray pattern
- Use on all boom times

Advantages

- 7° backward spray inclination reduces the jet force and ensures gentle application
- Optimized bore arrangement for enhanced cross distribution – patent pending
- Nozzle sizes FS 06 to FS 15 with oval bores for gentle fertilizer jets – gentle application of large amounts
- Dosing orifice can be removed without tools for cleaning



Series FS



Orifice can be removed without tools

Dimensions in mm.

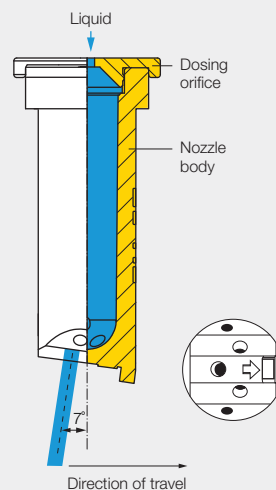
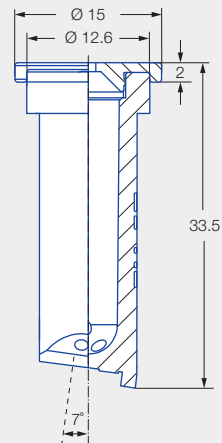

Application:

Liquid fertilizer delivery

Technical data:

Nozzle sizes
015–15

Spray angle
100°

Material
POM

Pressure ranges

- FS 015 to -08: 1–4 bar
- FS 10 and 15: 1–3 bar



Recommended strainer
25 M

Droplet size
Ultra coarse

Width across flats
10 mm

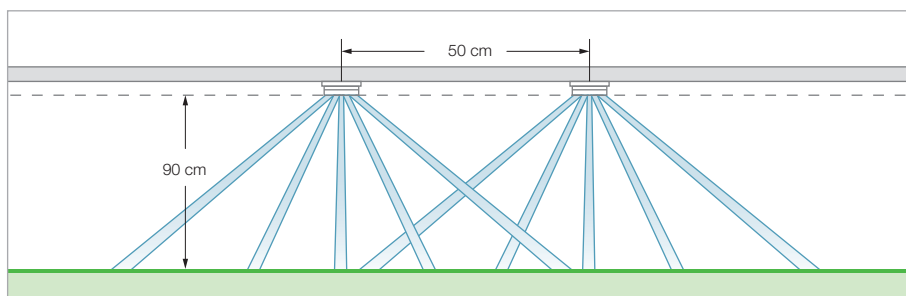
Spray heights
80–90–100 cm

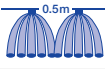

			[l/min]		UAN [l/ha] 							
			Water	UAN	5.0 km/h	6.0 km/h	7.0 km/h	8.0 km/h	10.0 km/h	12.0 km/h	14.0 km/h	16.0 km/h
FS 015 (25 M)	1.0	0.34	0.30	72	60	51	45	36	30	26	23	20
	1.5	0.42	0.37	89	74	63	55	44	37	32	28	25
	2.0	0.48	0.42	101	84	72	63	51	42	36	32	28
	2.5	0.54	0.48	114	95	81	71	57	48	41	35	32
	3.0	0.59	0.52	125	104	89	78	62	52	45	39	35
FS 02 (25 M)	1.0	0.46	0.40	97	81	69	61	49	40	35	31	27
	1.5	0.57	0.50	120	100	86	75	60	50	43	38	33
	2.0	0.65	0.57	137	114	98	86	69	57	49	43	38
	2.5	0.73	0.64	154	128	110	96	77	64	55	48	43
	3.0	0.80	0.70	169	141	121	106	84	70	60	53	47
FS 03 (25 M)	1.0	0.69	0.61	146	121	104	91	73	61	52	45	40
	1.5	0.84	0.74	177	148	127	111	89	74	63	56	49
	2.0	0.97	0.85	205	171	146	128	102	85	73	65	57
	2.5	1.09	0.96	230	192	164	144	115	96	82	72	64
	3.0	1.19	1.05	251	209	180	157	126	105	90	79	70
FS 04 (25 M)	1.0	0.91	0.80	192	160	137	120	96	80	69	60	53
	1.5	1.12	0.99	237	197	169	148	118	99	84	74	66
	2.0	1.29	1.14	272	227	195	170	136	114	97	86	76
	2.5	1.44	1.27	304	253	217	190	152	127	109	95	84
	3.0	1.58	1.39	334	278	238	209	167	139	119	104	93
FS 05 (25 M)	1.0	1.14	1.00	241	201	172	150	120	100	86	75	67
	1.5	1.39	1.22	294	245	210	183	147	122	105	92	82
	2.0	1.61	1.42	340	283	243	213	170	142	121	107	94
	2.5	1.80	1.58	380	317	272	238	190	158	136	119	106
	3.0	1.97	1.73	416	347	297	260	208	173	149	130	116
FS 06 (25 M)	1.0	1.36	1.20	287	239	205	180	144	120	103	90	80
	1.5	1.67	1.47	353	294	252	220	176	147	126	110	98
	2.0	1.93	1.70	408	340	291	255	204	170	146	128	113
	2.5	2.15	1.89	454	378	324	284	227	189	162	143	126
	3.0	2.36	2.08	498	415	356	312	249	208	178	156	138
FS 08 (25 M)	1.0	1.82	1.60	384	320	275	240	192	160	137	121	107
	1.5	2.23	1.96	471	392	336	294	235	196	168	148	131
	2.0	2.58	2.27	545	454	389	341	272	227	195	170	151
	2.5	2.88	2.53	608	507	434	380	304	253	217	191	169
	3.0	3.16	2.78	667	556	477	417	334	278	238	209	185
FS 10 (25 M)	1.0	2.27	2.00	479	400	342	300	240	200	171	150	133
	1.5	2.79	2.46	589	491	421	368	295	246	210	184	164
	2.0	3.22	2.83	680	567	486	425	340	283	243	212	189
	2.5	3.60	3.17	760	634	543	475	380	317	272	238	211
	3.0	3.94	3.47	832	693	594	520	416	347	297	260	231
FS 15 (25 M)	1.0	3.41	3.00	720	600	514	450	360	300	257	225	200
	1.5	4.18	3.68	883	736	631	552	441	368	315	276	245
	2.0	4.83	4.25	1,020	850	729	638	510	425	364	319	283
	2.5	5.40	4.75	1,140	950	815	713	570	475	407	356	317
	3.0	5.91	5.20	1,248	1,040	892	780	624	520	446	390	347

- Operating pressure at the nozzle (measured with diaphragm valve)
- The stated liter-per-hectare rates apply to UAN (28/1.28 kg/l)
- Nozzle spacing 0.5 m
- Verify the table values by gauging the flow rates prior to every spraying season
- Ensure uniform nozzle adjustment

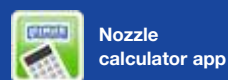

The apps for Lechler agricultural nozzles make selection and use of the optimum nozzle even easier. Find out more here: www.lechler.com/de-en/service/apps



Ordering example: Series FS + Nozzle size 04 + Material (POM) = Order No. FS 04

5-orifice nozzles FL

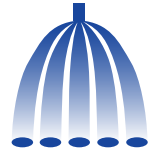

Crop production / Ground care

Dimensions in mm.

- Orifice nozzle with horizontal spray pattern

Advantages

- Black, gray and stainless steel nozzle sizes can be combined with dosing orifices
- Change in delivery rate by changing the dosing orifice
- No leaf damage due to extremely coarse droplets
- Suitable for PWM

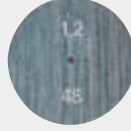

Installation instruction

Inscription on dosing orifice must face upwards when inserted in the bayonet cap!



FL black



FL stainless steel

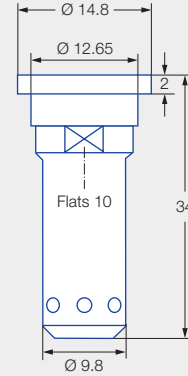

Series FL

Application:



Liquid fertilizer delivery



Dropleg^{UL}

Technical data:



Bore diameter
0.8–1.8 mm



Spray angle
160°



Materials

- Nozzle housing: POM, stainless steel
- Dosing orifice: Stainless steel



Pressure ranges

- Dosing orifice 0.8–1.0: **1–5 bar**
- Dosing orifice 1.2: **1–4 bar**
- Dosing orifice 1.5–1.8: **1–3 bar**



Recommended strainer
25 M



Droplet size
Ultra coarse



Width across flats
10 mm



Spray height
100 cm

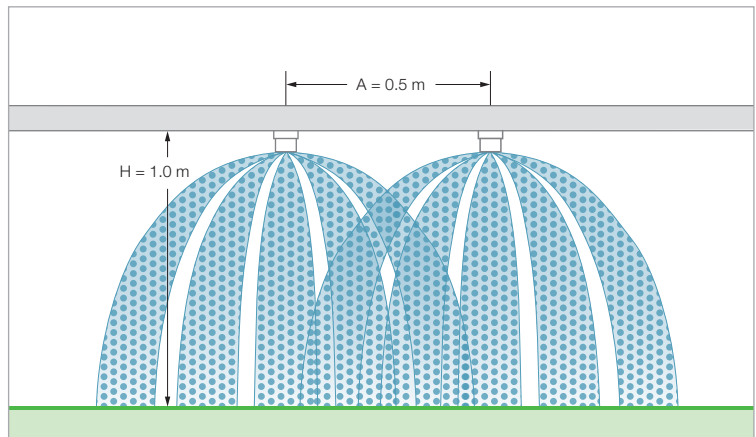
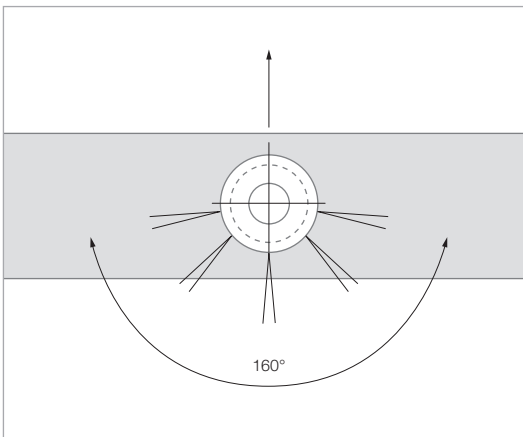

Good to know

You can find detailed information in our brochure "Application of liquid fertilizer" and at www.lechler-agri.com



Ø [mm]	[l/min]	UAN [l/ha]													
		Water	UAN	5.0 km/h	6.0 km/h	7.0 km/h	8.0 km/h	9.0 km/h	10.0 km/h	11.0 km/h	12.0 km/h	14.0 km/h	16.0 km/h	18.0 km/h	
0.8/32	1.0	0.31	0.27	66	55	47	41	37	33	30	27	23	20	18	
	2.0	0.43	0.38	91	76	65	57	51	46	41	38	33	29	25	
	3.0	0.53	0.47	112	94	80	70	62	56	51	47	40	35	31	
	4.0	0.61	0.54	129	108	92	81	72	65	59	54	46	40	36	
	5.0	0.68	0.60	144	120	103	90	80	72	66	60	52	45	40	
1.0/39	1.0	0.46	0.41	98	81	70	61	54	49	44	41	35	30	27	
	2.0	0.65	0.57	138	115	98	86	77	69	63	57	49	43	38	
	3.0	0.80	0.71	170	141	121	106	94	85	77	71	61	53	47	
	4.0	0.92	0.81	195	163	139	122	108	98	89	81	70	61	54	
	5.0	1.03	0.91	218	182	156	137	121	109	99	91	78	68	61	
1.2/48	1.0	0.67	0.59	142	118	102	89	79	71	65	59	51	44	39	
	2.0	0.95	0.84	202	168	144	126	112	101	92	84	72	63	56	
	3.0	1.16	1.03	246	205	176	154	137	123	112	103	88	77	68	
	4.0	1.34	1.18	284	237	203	178	158	142	129	118	102	89	79	
1.5/59	1.0	0.98	0.87	208	173	148	130	115	104	94	87	74	65	58	
	2.0	1.38	1.22	293	244	209	183	163	146	133	122	105	91	81	
	3.0	1.69	1.49	359	299	256	224	199	179	163	149	128	112	100	
1.8/72	1.0	1.39	1.23	295	246	211	184	164	147	134	123	105	92	82	
	2.0	1.96	1.73	416	346	297	260	231	208	189	173	148	130	115	
	3.0	2.40	2.12	509	424	364	318	283	255	231	212	182	159	141	

- Operating pressure at the dosing orifice (measured with diaphragm valve)
- Lateral nozzle spacing 0.5 m
- Verify the table values by gauging the flow rates prior to every spraying season
- Make sure that the same dosing orifices are fitted in the nozzles
- The stated liter-per-hectare rates apply to UAN (28/1.28 kg/l)

Ordering

When ordering, please specify the order numbers of the nozzle and also the dosing orifice.

Recommendation

Use only gray 5-orifice nozzles (**Order No. 500.179.56.01**) in combination with large dosing orifices (1.5 and 1.8 mm).

Designation	Order No.
5-orifice nozzles FL (supplied without dosing orifices, please order separately)	
<input type="checkbox"/> Stainless steel for all dosing orifice sizes	500.179.16
<input checked="" type="checkbox"/> POM for dosing orifices with dia. 0.8/1.0/1.2 mm	500.179.56.00
<input type="checkbox"/> POM for dosing orifices with dia. 1.2/1.5/1.8 mm	500.179.56.01
Dosing orifices	
0.8 mm/32 stainless steel	050.030.1C.00.00
1.0 mm/39 stainless steel	050.030.1C.01.00
1.2 mm/48 stainless steel	050.030.1C.03.00
1.5 mm/59 stainless steel	050.030.1C.02.00
1.8 mm/72 stainless steel	050.030.1C.04.00



Nozzle calculator app

The apps for Lechler agricultural nozzles make selection and use of the optimum nozzle even easier. Find out more here: www.lechler.com/de-en/service/apps



Hose drop system 5S und 5SL

Crop production

- Flexible hose drop system for late liquid fertilizer application

Advantages

- No scorching because weight-loaded 5-orifice tip is submerged in crop
- 5-orifice tip distributes the liquid fertilizer uniformly in the crop with 0.5 m hose spacing
- Lower boom loading when pulling through the crop in comparison with 0.25 m hose drop system
- Compliance with transport width through ideal adaption of the hose when the boom is folded
- Extension as spacer with hose attachment prevents paint damage to the sprayer when folded in
- Including bayonet cap system MULTIJET (incl. gasket) as standard

Application:



Liquid fertilizer delivery

- 5S: 50–300 l/ha UAN
- 5SL: 180–550 l/ha UAN

Technical data:



Hose spacing

- 0.5 m cereal crops, rape seed
- 0.75 m corn



ISO dosing orifice

- 5S: 02 and 03
- 5SL: 04, 05 and 06



Spray angle

160°



Pressure ranges

1–5 bar

Series 5S/5SL



Dimensions in mm.

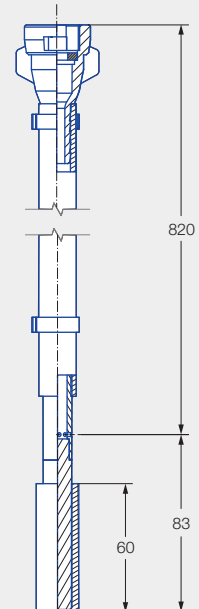

Assembly



Mounting instruction

Fit hose drop system 5S and 5SL facing forwards in driving direction when assembling on the field spray boom. When the system floats up slightly, the nozzle will then spray directly into the crop.

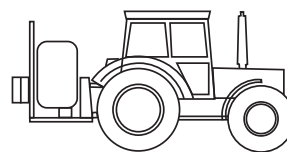



Direction of travel = spraying direction

Guide hose drop system 5S and 5SL 5 to 10 cm above the soil.

Good to know

You can find detailed information in our brochure "Application of liquid fertilizer" and at www.lechler-agri.com



Ø [mm]	[bar]	[l/min]		UAN (28) [l/ha] 					UAN (28) [l/ha] 					
		Water	UAN (28)	5.0 km/h	6.0 km/h	7.0 km/h	8.0 km/h	10.0 km/h	5.0 km/h	6.0 km/h	7.0 km/h	8.0 km/h	10.0 km/h	
5S	02	1.0	0.46	0.41	98	81	70	61	49	65	54	46	41	33
		2.0	0.65	0.57	138	115	98	86	69	92	77	66	57	46
		3.0	0.80	0.71	170	141	121	106	85	113	94	81	71	57
		4.0	0.92	0.81	195	163	139	122	98	130	108	93	81	65
		5.0	1.03	0.91	218	182	156	137	109	146	121	104	91	73
	03	1.0	0.69	0.61	146	122	105	91	73	98	81	70	61	49
		2.0	0.97	0.86	206	171	147	129	103	137	114	98	86	69
		3.0	1.19	1.05	252	210	180	158	126	168	140	120	105	84
		4.0	1.37	1.21	291	242	208	182	145	194	161	138	121	97
		5.0	1.54	1.36	327	272	233	204	163	218	181	156	136	109
5SL	04	1.0	0.91	0.80	193	161	138	121	97	129	107	92	80	64
		2.0	1.29	1.14	274	228	195	171	137	182	152	130	114	91
		3.0	1.58	1.40	335	279	239	209	168	223	186	160	140	112
		4.0	1.82	1.61	386	322	276	241	193	257	214	184	161	129
		5.0	2.04	1.80	433	361	309	270	216	288	240	206	180	144
	05	1.0	1.14	1.01	242	202	173	151	121	161	134	115	101	81
		2.0	1.61	1.42	342	285	244	213	171	228	190	163	142	114
		3.0	1.97	1.74	418	348	299	261	209	279	232	199	174	139
		4.0	2.27	2.01	482	401	344	301	241	321	268	229	201	161
		5.0	2.54	2.25	539	449	385	337	269	359	299	257	225	180
	06	1.0	1.36	1.20	288	240	206	180	144	192	160	137	120	96
		2.0	1.93	1.71	409	341	292	256	205	273	227	195	171	136
		3.0	2.36	2.09	501	417	358	313	250	334	278	238	209	167
		4.0	2.73	2.41	579	483	414	362	290	386	322	276	241	193
		5.0	3.05	2.70	647	539	462	404	324	431	359	308	270	216



- Operating pressure at the dosing orifice (measured with diaphragm valve)
- Hose spacing 0.5/0.75 m
- Verify the table values by gauging the flow rates prior to every spraying season
- Make sure that the same dosing orifices are fitted in the hoses
- The stated liter-per-hectare rates apply to UAN (28/1.28 kg/l)



Recommendation

Relocation kit for variable row adaptation.





Order No.:
092.174.00.00.00
(see Page 130).

Description		Order No.
Hose drop system 5S		092.173.00
Dosing orifices		
ISO 02 (formerly: 1.0/39) ¹		600.500.56.02.40.0
ISO 03 (formerly: 1.2/48) ¹		600.500.56.03.40.0
Hose drop system 5SL		092.173.00.01.00
Dosing orifices		
ISO 04 (formerly: 1.5/59) ¹		600.500.56.04.40.0
ISO 05		600.500.56.05.40.0
ISO 06 (formerly: 1.8/72) ¹		600.500.56.06.40.0

Liter per hectare rates as for FL nozzle (see Page 91).

¹ Stainless steel dosing orifice up to 2019.

Accessories

Description		Order No.
Securing clip		092.164.56.00.10.0
Extra-high 4 mm gasket		095.015.6C.02.85.0
Intermediate adapter for system Lechler TWISTLOC		092.163.56.00.22.1
Intermediate adapter for system Rau		092.163.56.00.21.0
Intermediate adapter for system Hardi		092.163.56.00.20.1



Nozzle calculator app

The apps for Lechler agricultural nozzles make selection and use of the optimum nozzle even easier. Find out more here: www.lechler.com/de-en/service/apps



Air injector IS 80

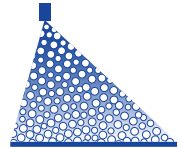

Crop production / Ground care

- Air-aspirating off center nozzle for border application and banding
- Extremely low-drift

Advantages

- 90 % drift reduction for band spraying with IS 80-03
- Same JKI drift reduction class in combination with ID/IDTA nozzles in the field spray boom
- Volume flow adapted for optimum cross distribution in combination with ID/IDTA nozzles of the same size
- Asymmetrical spray pattern (20°/60° to axis)
- Precise edge application along water courses and field boundaries
- Optimum protection of neighboring crops (field border application) or row/special cultures (herbicide underleaf spraying/banding)
- Suitable for PWM



Series IS 80



Injector can be removed without tools

Dimensions in mm.

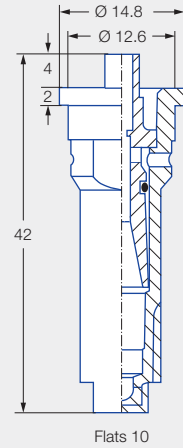

Flats 10

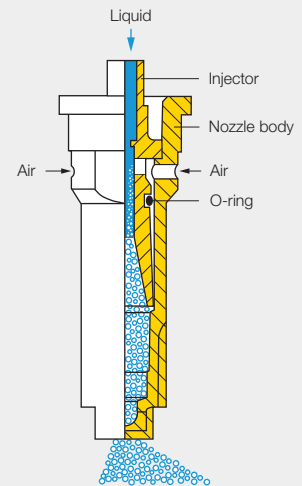

JKI approval as loss-reducing: 90/75/50 %

G 1682, G 1753, G 1754, G 1755, G 1999, G 2000, G 2087

JKI approval with ID/IDTA nozzles of the same size.



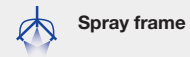

Current list at: www.lechler.com/de-en/service/loss-reducing

Application:

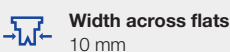
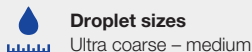
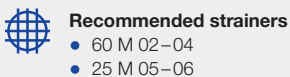
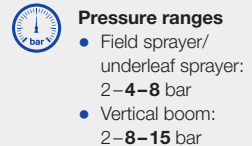
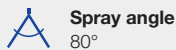
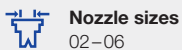

Technical data:



	IS	Series	[l/min]						
									
			2.0	3.0	4.0	5.0	6.0	7.0	8.0
	IS 80-02	60 M	0.49	0.60	0.69	0.77	0.84	0.91	0.97
	IS 80-025	60 M	0.70	0.86	0.90	1.13	1.24	1.34	1.43
	IS 80-03	60 M	0.86	1.05	1.21	1.35	1.48	1.60	1.71
	IS 80-04	60 M	1.11	1.36	1.57	1.75	1.92	2.07	2.21
	IS 80-05	25 M	1.23	1.51	1.74	1.95	2.14	2.31	2.47
	IS 80-06	25 M	1.36	1.67	1.93	2.16	2.37	2.56	2.73

- The stated l/ha values apply to water
- Check the nozzles by gauging the flow rates prior to every spraying season
- Pressure measured at the nozzle

If necessary, please ask for additional information material on installation instructions for broadcast spraying A100 and banding in orchards and vineyards A200.

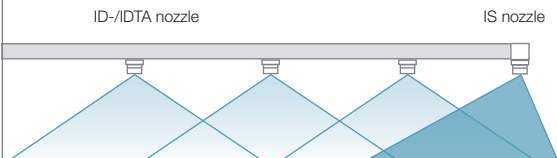

ID-/DTA nozzle



IS nozzle

Precise border spraying

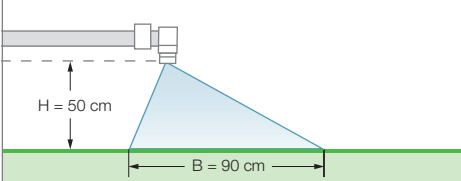

H = 50 cm
B = 90 cm

Spray dimensions

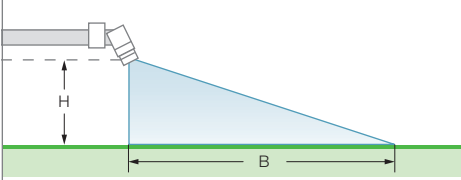

H
B

Band spraying in orchards and vineyards

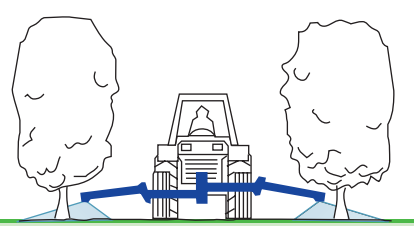

Underleaf spraying in row crops



Accessories: swivel nozzle holders etc. (see Page 128)

Ordering example: Series IS 80 + Nozzle size 02 + Material (POM) = Order No. IS 80-02

Compact air-injector off center spray nozzles IDKS 80

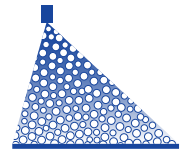

Crop production / Ground care

- Compact, air-aspirating off center nozzle for border application and banding
- Very low drift

Advantages

- 90 % drift reduction for band spraying with IDKS 80-025 to -06
- Same JKI drift reduction class in combination with IDK/IDKN/IDKT nozzles in the field spray boom
- Volume flow adapted for optimum cross distribution in combination with IDK/IDKN/IDKT nozzles of the same size
- Precise edge application along water courses and field boundaries
- Optimum protection of neighboring crops (field edge application) or row/special cultures (herbicide underleaf spraying/banding)
- Suitable for PWM

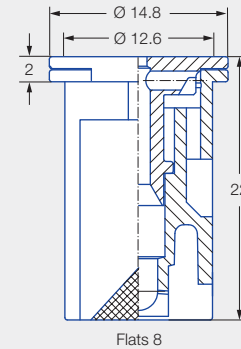

Series IDKS 80

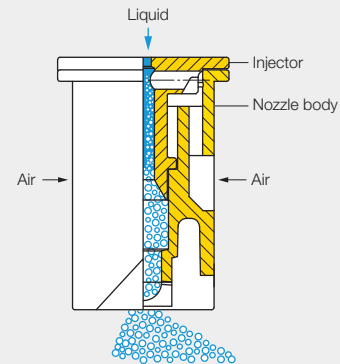

Injector can be removed
without tools



**JKI approval as
loss-reducing:
90/75/50 %**

G 1786, G 1787, G 1788, G 1789, G 1998,
G 2139, G 2140, G 2141, G 2142, G 2143

JKI approval with IDK/ IDKN/IDKT nozzles of
the same size.



Current list at:
[www.lechler.com/de-en/
service/loss-reducing](http://www.lechler.com/de-en/service/loss-reducing)

Application:



Border nozzle



Plant protection in
viticulture, orchard
and specialty crops



Vertical boom



Spray frame



Backpack sprayer



Greenhouse

Technical data:



Nozzle sizes
015–06



Spray angle
80°



Material
POM



Pressure ranges

- Field sprayer/
underleaf sprayer:
1–1.5–3–6 bar
- Vertical boom:
1–8–15 bar



Recommended strainers









- 60 M 015–04
- 25 M 05–06



Droplet sizes
Ultra coarse – medium



Width across flats
8 mm

		[l/min]							
									
		1.0	1.5	2.0	3.0	4.0	5.0	6.0	
	IDKS 80-015	60 M	–	0.28	0.32	0.39	0.45	0.51	0.55
	IDKS 80-02	60 M	–	0.42	0.48	0.59	0.68	0.76	0.83
	IDKS 80-025	60 M	–	0.56	0.65	0.80	0.92	1.03	1.13
	IDKS 80-03	60 M	0.57	0.70	0.81	0.99	1.15	1.28	1.40
	IDKS 80-04	60 M	0.69	0.84	0.97	1.19	1.37	1.53	1.68
	IDKS 80-05	25 M	0.91	1.12	1.29	1.58	1.82	2.04	2.23
	IDKS 80-06	25 M	1.14	1.39	1.61	1.97	2.28	2.55	2.79

- The stated l/ha values apply to water
- Check the nozzles by gauging the flow rates prior to every spraying season
- Pressure measured at the nozzle

If necessary, please ask for additional information material on installation instructions for broadcast spraying A100 and banding in orchards and vineyards A200.

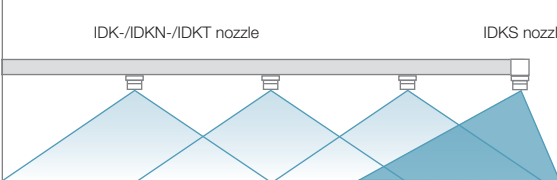

IDK-/IDKN-/IDKT nozzle



IDKS nozzle

Precise border spraying

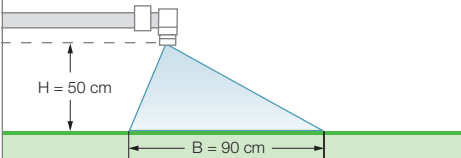

Spray dimensions

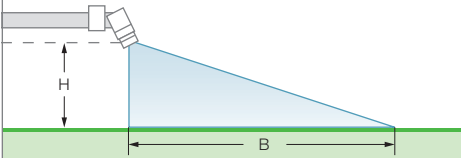

Accessories: swivel nozzle holders etc. (see Page 128)

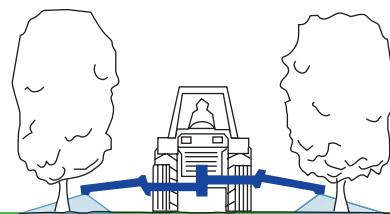

Band spraying in orchards and vineyards



Underleaf spraying in row crops



Recommendation

Optimum protection of IDKS nozzles thanks to long design of MultiCap (see Page 124).



Nozzle calculator app

The apps for Lechler agricultural nozzles make selection and use of the optimum nozzle even easier.

Find out more here:
www.lechler.com/de-en/service/apps



Ordering example: Series IDKS 80 + Nozzle size 02 + Material (POM) = Order No. IDKS 80-02

Wide-throw nozzles BN

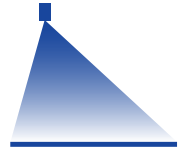

Crop production / Ground care

- Off center nozzle with wide throw characteristic
- For area spraying without spray boom and for border application and banding

Advantages

- Asymmetrical flat spray nozzle
- Robust and clogging resistant flood nozzle design
- Spraying on both sides with max. 2.75 m spray band width with 0.5 m spray height
- Color marking of left-spraying nozzle (white) and right-spraying nozzle (black)
- Uniform cross distribution of nozzle combination



BN 07 L



BN 07 R

Series BN

Dimensions in mm.

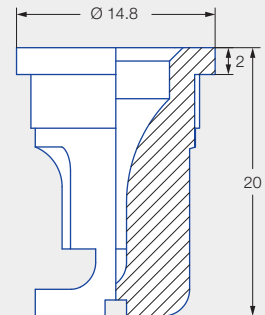

Application:



Banding



Boomless application

Technical data:



Nozzle size
07



Spray angle
100°



Material
POM



Pressure ranges
1–2–4–6 bar



Recommended strainer
25 M



Droplet sizes
Medium – fine



Union nut
Ø 12.65 mm

		[l/min]					
		1.0	2.0	3.0	4.0	5.0	6.0
BN 07	25 M	1.59	2.25	2.76	3.18	3.56	3.90

Nozzle arrangement in the system

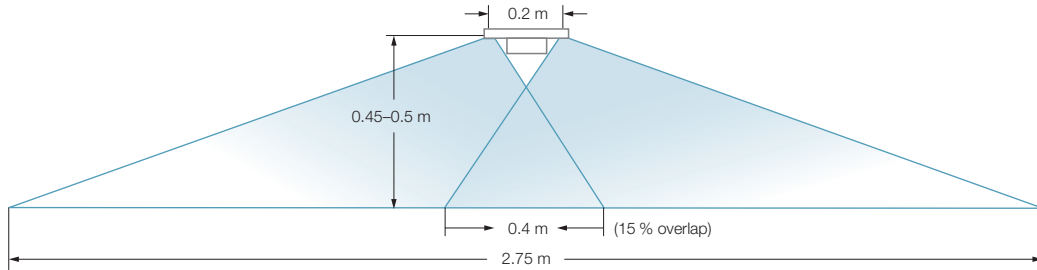

Fixed installation of BN nozzle using special bayonet cap system MULTIJET (see Page 124) and TWISTLOC (see Page 126) for flood nozzles.

Assembly



Alternatively, nozzle assembly with a round hold bayonet cap (see Page 127) or union nut 3/8" (see Page 131).

Correct adjustment and alignment is performed by turning the nozzle, with a screwdriver at the tongue slot.



Ordering example:	Series	+ Nozzle size	+ Material	= Order No.
	BN	+ 07	+ POM L (white)	= BN 07 L
	BN	+ 07	+ POM R (black)	= BN 07 R

Off center nozzles OC

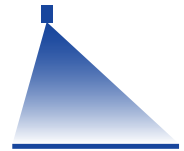

Crop production / Ground care

Dimensions in mm.

- Off center nozzle for border application and banding

Advantages

- Laterally offset orifice
- Asymmetrical flat spray nozzle

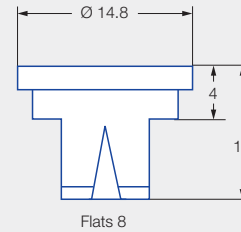

Series OC

Application:



Border nozzle



Band spraying in orchards and vineyards



Vertical boom



Spray frame



Backpack sprayer



Greenhouse



Riding arena floor

Technical data:



Nozzle sizes
2–30



Spray angle
90°



Materials
Brass, stainless steel



Pressure ranges
1.5–2.5–5 bar



Recommended strainers
• 60 M 2–4
• 25 M 5–30



Droplet sizes
Medium – fine



Width across flats
8 mm

Spray dimensions

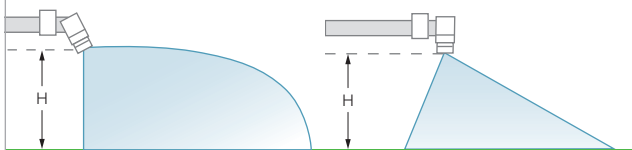

OC nozzle tips fitted in individual or double swivel joints (see Page 128) permit adjustment to any angle. Wide and narrow spray jet widths can be achieved in this way.

Precise border spraying

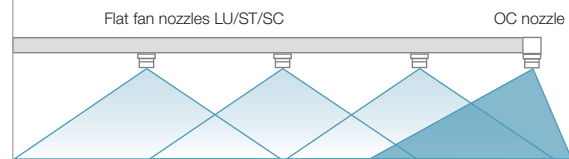

		[l/min]				
						
		1.5	2.0	3.0	4.0	5.0
OC 2	60 M	0.49	0.65	0.80	0.92	1.03
OC 3	60 M	0.88	1.01	1.24	1.43	1.60
OC 4	60 M	1.11	1.28	1.56	1.81	2.02
OC 5	25 M	1.37	1.58	1.94	2.24	2.50
OC 6	25 M	1.64	1.90	2.32	2.68	3.00
OC 8	25 M	2.16	2.50	3.06	3.53	3.95
OC 12	25 M	3.47	4.00	4.90	5.66	6.33
OC 20	25 M	5.45	6.30	7.71	8.91	9.96
OC 30	25 M	8.66	10.00	12.25	14.14	15.81

- The stated l/ha values apply to water
- Check the nozzles by gauging the flow rates prior to every spraying season
- Pressure measured at the nozzle

Nozzle size in boom (LU/ST/SC)	Required OC end nozzle
	Precise border spraying
-02	OC 2
-03	OC 3
-04	OC 4
-05	OC 5
-06	OC 6
-08	OC 8

Nozzle adjustment



Underleaf spraying in row crops

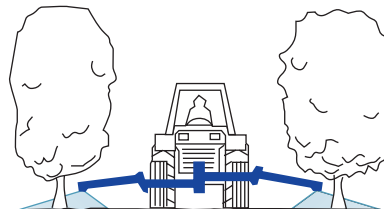

Band spraying in orchards and vineyards

Ordering example:	Series	+	Nozzle size	+	Material	=	Order No.
	OC	+	2	+	S (stainless steel)	=	OC 2 S
	OC	+	2	+	M (brass)	=	OC 2 M

Wide-throw nozzles

OC

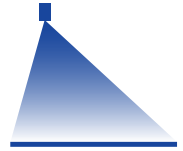

Crop production

Ground care

Dimensions in mm.

- Off center nozzle with large throw width

Advantages

- Laterally offset orifice
- Asymmetrical flat spray nozzle
- Spraying range 6 to 8 m

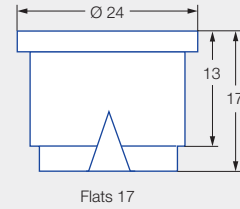

Wide-throw nozzle OC

Application:



Greenhouse



Riding arena floor



Boomless application

Technical data:



Nozzle sizes
40–80



Spray angle
90°



Material
Brass



Pressure ranges
2–5 bar



Recommended strainer
25 M



Droplet sizes
Medium – fine



Width across flats
17 mm

	[l/min]				Recommended nozzle combination with flat spray nozzles, e.g. with LU/IDK/IDKN nozzles
	2.0	3.0	4.0	5.0	
OC 40	12.50	15.30	17.70	19.80	-03/-04
OC 60	20.00	24.49	28.28	31.62	-05/-06
OC 80	25.00	30.62	35.36	39.53	-06/-08

- The stated l/ha values apply to water
- Check the nozzles by gauging the flow rates prior to every spraying season
- Pressure measured at the nozzle

Mounting on boom/nozzle adjustment

A wide-throw nozzle is fitted at each end of the boom. The individual nozzles are supplied via additional section valves or branches (with T connectors) from existing sufficiently dimensioned feedlines. It must be ensured that the equipment has a pump with a sufficiently high delivery (additional flow rate for two wide-throw nozzles approx. 80 l/min).

Position	Designation	Order No.
1	Wide-throw nozzle	OC 40 OC 60 OC 80
2	Union nut	065.600.30.00
3	Angle 90°, 3/4" male and female threads	see Page 135
4	Pipe clamp	-
5	Hose shank, 3/4"	see Page 132 + 133
6	Gasket	065.640.72.00

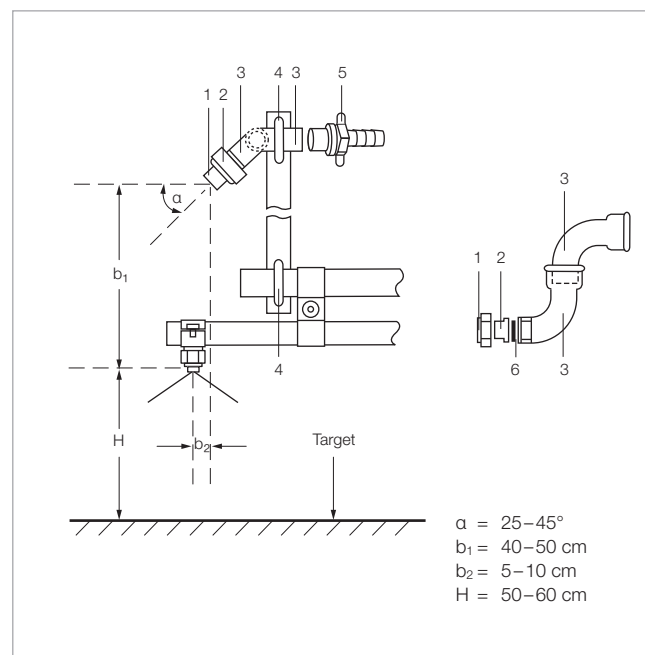

Spraying range/effective working width

The spraying range can be influenced by the setting angle α :

Setting angle, α [°]	Spraying range, a [m]
25	9.0
30	8.5
35	8.0
40	6.0
45	5.5

Assembly



Double nipple
Order No. **065.611.30**

Gasket
Order No. **065.640.72**

Wide-throw nozzle

Threaded cap 3/4"
Order No. **065.600.xx**
(brass or stainless steel)

Even flat fan nozzles E

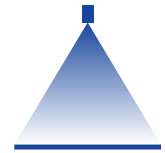

Crop production / Ground care

Dimensions in mm.

- Flat spray nozzle with rectangular liquid distribution
- For band and row spraying

Advantages

- 90 % drift reduction for 8002 to 8004 E
- Fully formed spray angle from 1 bar
- Uniform active ingredient distribution over the whole band width
- Extremely small spraying distances possible
- Suitable for PWM



E



E-M

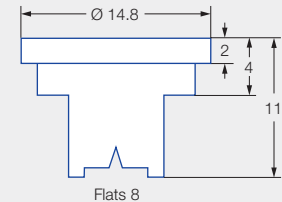

Series E

Spray height H [cm]	Band width B [cm]	Product application quantity ¹ [%], at row spacing A		
		50 cm	75 cm	100 cm
7	10	20	13	10
10	15	30	20	15
13	20	40	27	20
16	25	50	33	25

¹ Percentages, in comparison with full-area treatment.

Reduction in application rate

Depending on the band and row width, the amount of spraying liquid for band spraying amounts to 10–50 % of the amount for full-area treatment. Calculation formula for band and row spraying, see Page 9 and Lechler app.



JKI approval as loss-reducing: 90 %

G 1435, G 1436, G 1437, G 1438



Current list at:
www.lechler.com/de/service/verlust-mindernde-technik

Application:



Backpack sprayer



Band spraying

Technical data:



Nozzle sizes
01–08



Spray angle
80°



Materials
Brass, POM



Pressure ranges
1–3–4 bar



Recommended strainers

- 80 M 01–015
- 60 M 02–04
- 25 M 05–08



Droplet sizes
Very coarse – very fine



Width across flats
8 mm

Nozzle adjustment

Extremely small spray heights (H) possible with even flat fan nozzles E. Band drift can be largely avoided. The band width (B) can be adjusted by changing the spray height (H) and/or rotating the spray axis.

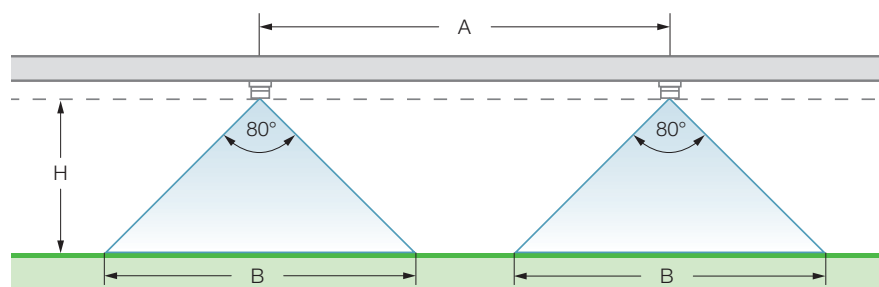

ISO 25358	[l/min]	Application rate [l/ha]																
		Row spacing 0.5 m					Row spacing 0.75 m					Row spacing 1.0 m						
		5.0 km/h	6.0 km/h	8.0 km/h	10.0 km/h	12.0 km/h	5.0 km/h	6.0 km/h	8.0 km/h	10.0 km/h	12.0 km/h	5.0 km/h	6.0 km/h	8.0 km/h	10.0 km/h	12.0 km/h		
E 8001 (80 M)	F	1.0	0.23	55	46	35	28	23	37	31	23	18	15	28	23	17	14	12
	F	1.5	0.28	67	56	42	34	28	45	37	28	22	19	34	28	21	17	14
	F	2.0	0.32	77	64	48	38	32	51	43	32	26	21	38	32	24	19	16
	VF	3.0	0.39	94	78	59	47	39	62	52	39	31	26	47	39	29	23	20
	VF	4.0	0.45	108	90	68	54	45	72	60	45	36	30	54	45	34	27	23
E 80015 (80 M)	F	1.0	0.34	82	68	51	41	34	54	45	34	27	23	41	34	26	20	17
	F	1.5	0.42	101	84	63	50	42	67	56	42	34	28	50	42	32	25	21
	F	2.0	0.48	115	96	72	58	48	77	64	48	38	32	58	48	36	29	24
	VF	3.0	0.59	142	118	89	71	59	94	79	59	47	39	71	59	44	35	30
	VF	4.0	0.68	163	136	102	82	68	109	91	68	54	45	82	68	51	41	34
E 8002 (60 M)	M	1.0	0.46	110	92	69	55	46	74	61	46	37	31	55	46	35	28	50
	M	1.5	0.56	134	112	84	67	56	90	75	56	45	37	67	56	42	34	57
	M	2.0	0.65	156	130	98	78	65	104	87	65	52	43	78	65	49	39	71
	F	3.0	0.80	192	160	120	96	80	128	107	80	64	53	96	80	60	48	57
	F	4.0	0.92	221	184	138	110	92	147	123	92	74	61	110	92	69	55	81
E 8003 (60 M)	C	1.0	0.72	173	144	108	86	72	115	96	72	58	48	86	72	54	43	36
	M	1.5	0.88	211	176	132	106	88	141	117	88	70	59	106	88	66	53	44
	M	2.0	1.01	242	202	152	121	101	162	135	101	81	67	121	101	76	61	51
	F	3.0	1.24	298	248	186	149	124	198	165	124	99	83	149	124	93	74	62
	F	4.0	1.43	343	286	215	172	143	229	191	143	114	95	172	143	107	86	72
E 8004 (60 M)	VC	1.0	0.91	218	182	137	109	91	146	121	91	73	61	109	91	68	55	46
	C	1.5	1.12	269	224	168	134	112	179	149	112	90	75	134	112	84	67	56
	C	2.0	1.29	310	258	194	155	129	206	172	129	103	86	155	129	97	77	65
	M	3.0	1.58	379	316	237	190	158	253	211	158	126	105	190	158	119	95	79
	M	4.0	1.82	437	364	273	218	182	291	243	182	146	121	218	182	137	109	91
E 8005 (25 M)	VC	1.0	1.14	274	228	171	137	114	182	152	114	91	76	137	114	86	68	57
	VC	1.5	1.39	334	278	209	167	139	222	185	139	111	93	167	139	104	83	70
	C	2.0	1.61	386	322	242	193	161	258	215	161	129	107	193	161	121	97	81
	M	3.0	1.97	473	394	296	236	197	315	263	197	158	131	236	197	148	118	99
	M	4.0	2.28	547	456	342	274	228	365	304	228	182	152	274	228	171	137	114
E 8006 (25 M)	VC	1.0	1.36	326	272	204	163	136	218	181	136	109	91	163	136	102	82	68
	VC	1.5	1.67	401	334	251	200	167	267	223	167	134	111	200	167	125	100	84
	VC	2.0	1.93	463	386	290	232	193	309	257	193	154	129	232	193	145	116	97
	C	3.0	2.36	566	472	354	283	236	378	315	236	189	157	283	236	177	142	118
	M	4.0	2.73	655	546	410	328	273	437	364	273	218	182	328	273	205	164	137
E 8008 (25 M)	VC	1.0	1.82	437	364	273	218	182	291	243	182	146	121	218	182	137	109	91
	VC	1.5	2.23	535	446	335	268	223	357	297	223	178	149	268	223	167	134	112
	VC	2.0	2.58	619	516	387	310	258	413	344	258	206	172	310	258	194	155	129
	C	3.0	3.16	758	632	474	379	316	506	421	316	253	211	379	316	237	190	158
	M	4.0	3.65	876	730	548	438	365	584	487	365	292	243	438	365	274	219	183

ISO 25358 classification according to droplet sizes:

- VF** Very fine
- F** Fine
- M** Medium
- C** Coarse
- VC** Very coarse
- EC** Extremely coarse
- UC** Ultra coarse

Subject to modifications.

- Operating pressure at the nozzle (measured with diaphragm valve)
- The stated liter-per-hectare rates apply to water
- Verify the table values by gauging the flow rates prior to every spraying season
- Pay attention to uniform nozzle adjustment



 **Nozzle calculator app**

The apps for Lechler agricultural nozzles make selection and use of the optimum nozzle even easier. Find out more here: www.lechler.com/de-en/service/apps

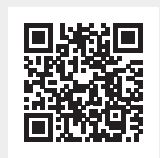

Ordering example:	Series	+	Nozzle size	+	Material	=	Order No.
	E	+	02	+	M (brass)	=	E 8002 M
	E	+	02	+	(POM)	=	E 8002

Injector agitator nozzles



- Agitator nozzle for fast, homogeneous mixing in tanks

Advantages

- Injector effect reinforces turbulence of the solid jet in the tank
- Effective circulation of large flow quantities with a relatively small flow rate
- Clog-resistant due to large cross-sections



Injector agitator nozzle

Dimensions in mm.

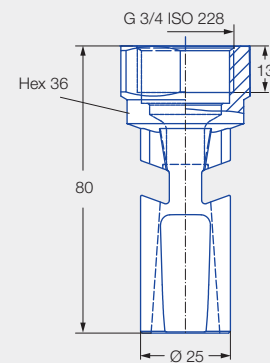
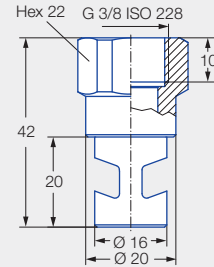

Technical data:



Bore diameter
Ø 2.2 – 10.55 mm



Material
PP



Pressure ranges
2–10 bar

Order No.	Bore diameter [mm]	\dot{V} [l/min]				
		2.0 bar	4.0 bar	6.0 bar	8.0 bar	10.0 bar
500.262.53.02	2.20	4.40	6.30	7.70	8.90	9.90
500.262.53.04	3.60	11.10	15.70	19.20	22.10	27.70
500.262.53.06	4.50	18.30	26.00	31.80	36.70	41.00
500.262.53.08	6.00	31.60	44.70	54.80	63.20	70.70
500.262.53.20 ¹	10.55	96.10	136.00	166.50	192.30	215.00

¹ See dimensioning.

Assembly

Assembly with eyelet connector (see Page 128).

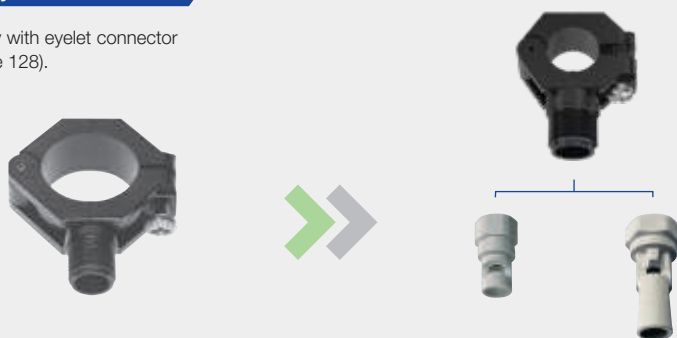

Cleaning nozzle for induction hoppers WallCleaner



- Special nozzle for induction hoppers for induction and cleaning
- Color-coded in accordance with ISO 10625, in size 40

Advantages

- Lump-free induction of plant protection products by rotating liquid flow
- Complete rinsing of inner wall up to under the edge for round induction hoppers
- Simple assembly by
 - M 16 bolt/nut design
 - Plug connection for rinsing water (dia. 12 mm)
- Simple alignment of nozzle head with open-end wrench AF 24



WallCleaner

Dimensions in mm.

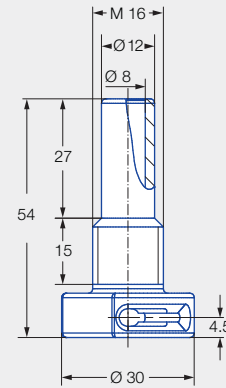

Technical data:



Bore diameter
Ø 4.0 mm



Spray angle
60°



Material
POM



Pressure ranges
2–4–8 bar

Designation	Order No.	Bore diameter [mm]	V̇ [l/min]			
			2.0 bar	4.0 bar	6.0 bar	8.0 bar
WallCleaner 40	600.569.56.40	4.0	14.0	19.8	24.3	28.0
Gasket for WallCleaner	095.015.6C.01.99	–	–	–	–	–

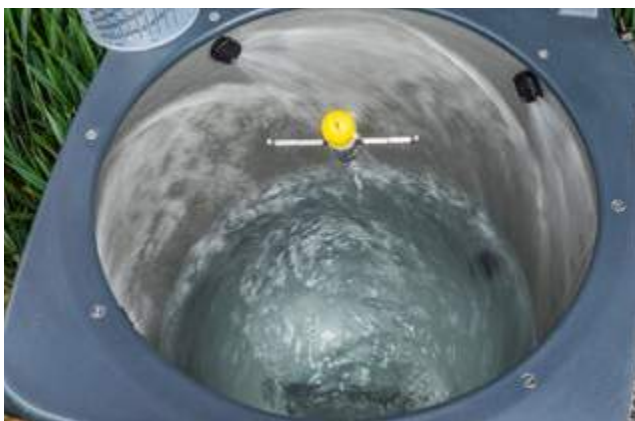

Complete rinsing of induction hopper up to under the cover edge with a total of four WallCleaner nozzles.

High-pressure fog nozzle 2MN



Dimensions in mm.

- High-pressure fog nozzle
- For air moisturization, adiabatic cooling and disinfection in livestock buildings and greenhouses

Advantages

- Extremely fine, mist-like hollow cone atomization
- Integrated non-return valve

Connection

- 10–24 UNC

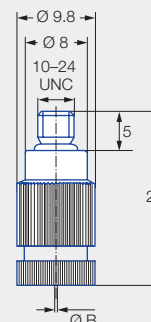

Other variants on request:

- Bore diameter
 - 0.6 mm
 - 0.7 mm
- Connections
 - 12–24 UNC
 - M5
- Material
 - Stainless steel 1.4404
- Gasket
 - FKM/Viton (brown)
- Blanking plug

Series 2MN

Application:



Greenhouse



Livestock buildings

Technical data:



Bore diameter
0.15–0.5 mm
0.6 and 0.7 mm
on request



Spray angles
55°–95°



Materials
Stainless steel 1.4305,
Nozzle tip 1.4404,
spring 1.4310,
gaskets NBR (black)



Pressure ranges
30–60–80–130 bar

Spray angle	Order No.		B Ø [mm]	V̇ [l/h]							
		Stainless steel 1.4305		p [bar] (p _{min} = 30 bar) ¹ (p _{max} = 130 bar) ²							
				30	40	50	60	70	80	90	100
55°	2MN.014.16.00.00	●	0.15	1.44	2.28	2.58	2.82	3.00	3.48	3.84	4.08
70°	2MN.025.16.00.00	●	0.20	2.46	3.42	3.78	4.26	4.50	5.10	5.10	5.46
85°	2MN.055.16.00.00	●	0.30	4.20	4.92	5.46	6.12	6.30	6.96	7.32	7.92
90°	2MN.086.16.00.00	●	0.40	5.64	6.96	7.68	8.52	9.00	9.54	10.14	11.10
95°	2MN.106.16.00.00	●	0.50	7.02	8.16	9.60	10.80	11.40	11.70	12.54	13.68

¹ Opening pressure: approx. 8 bar.

² The pipe system is the limiting factor.

High- and medium-pressure cleaning nozzles

- Solid and flat spray nozzles for high- and medium-pressure cleaning

Advantages

- Maximum cleaning force for razor-sharp cleaning jets
- Wear-resistant special stainless steel for long service life
- Protection against mechanical damage through recessed outlet opening
- Maximum precision for uniform, concentrated jet force
- Connection possible via male thread and union nut

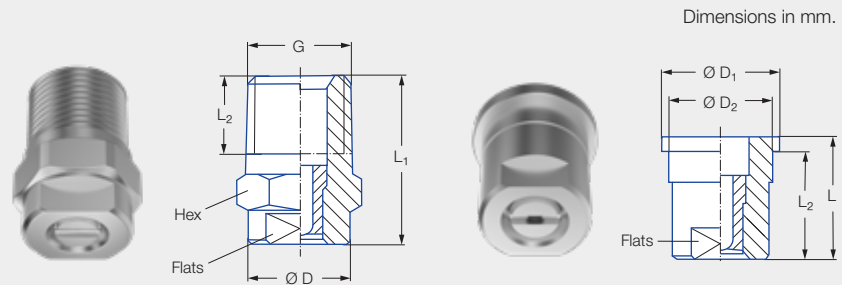

Flat fan nozzles

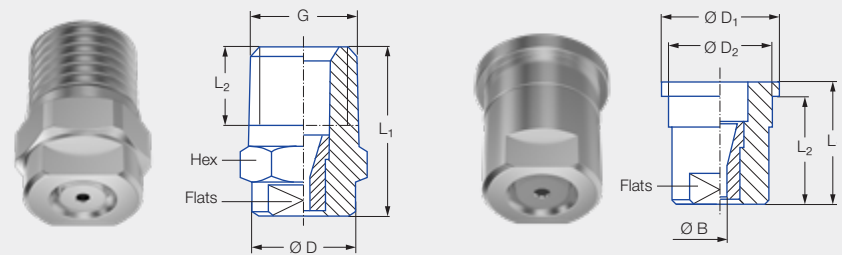

Solid stream nozzles

G	Dimensions [mm]								Weight [g]	p _{max} ¹ [bar]
	L ₁	L ₂	Ø D	Ø D ₁	Ø D ₂	Flats	Hex	Flats		
EN 10226 R 1/4	22.00	10.00	13.00	-	-	-	14	10	18.00	approx. 700
1/4 NPT	22.00	10.00	13.00	-	-	-	14	10	18.00	approx. 700
Assembly with union nut G 3/8 ISO 228	16.00	14.00	-	14.80	12.65	10	-	-	13.00	approx. 300

¹ Applies only to operation with constant pressure.

Technical data:



Nozzle sizes
04-06



Spray angles
0°-40°



Material
Hardened stainless steel (carbide insert on request)



Pressure ranges
5-40-200 bar



Width across flats
10 mm

Spray angle	Nozzle size	V̇ [l/min]			Order No.		
		[bar]			Male thread		Version for union nut
		5.0	60.0	100.0	1/8" NPT	1/4" NPT	G 3/8
0°	04	2.04	7.1	9.2	550.450	546.450	548.450
	05	2.55	8.9	11.5	550.480	546.480	548.480
	06	3.05	10.6	13.6	550.520	546.520	548.520
15°	04	2.04	7.1	9.2	608.451	602.451	652.451
	05	2.55	8.9	11.5	608.481	602.481	652.481
	06	3.05	10.6	13.6	608.521	602.521	652.521
25°	04	2.04	7.1	9.2	608.452	602.452	652.452
	05	2.55	8.9	11.5	608.482	602.482	652.482
	06	3.05	10.6	13.6	608.522	602.522	652.522
40°	04	2.04	7.1	9.2	608.453	602.453	652.453
	05	2.55	8.9	11.5	608.483	602.483	652.483
	06	3.05	10.6	13.6	608.523	602.523	652.523

Fan nozzles

- Special nozzle for gentle delivery of large liquid quantities

Advantages

- Fine, gentle atomization
- Gentle plant irrigation
- Effective disinfection of livestock buildings. Please observe the safety instructions of the product manufacturer
- Optionally available with spray gun and GEKA connection coupling

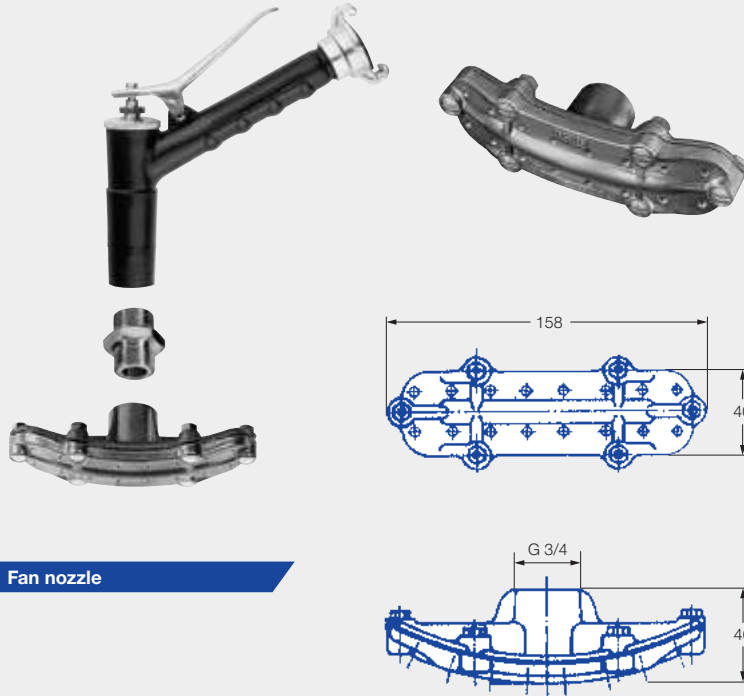

Dimensions in mm.

Fan nozzle

Technical data:

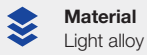

Material
Light alloy



Pressure ranges
2–10 bar

Order No.	
Spray gun with GEKA connection coupling	Double nipple G 3/4
095.016.00.01.76	065.611.30

Order No.	Flow rate [l/min]		
	2.0 bar	5.0 bar	10.0 bar
Nozzle without stay tube Connection G 3/4			
531.003.41.00	31.5	49.8	70.4
531.093.41.00	53.0	83.8	119.0
531.133.41.00	67.0	106.0	150.0



Automatic valves for canister cleaning

CleanerValve and dead man's circuit

- Safety valves with dead man's circuit for practical canister cleaning

Advantages of CleanerValve

- Better cleaning effect due to deeper nozzle insertion into the canister
- Very robust valve made of stainless steel
- Extra-wide bearing area for easy cleaning of measuring cups
- User protection: gradings on the bearing area prevent slipping



CleanerValve

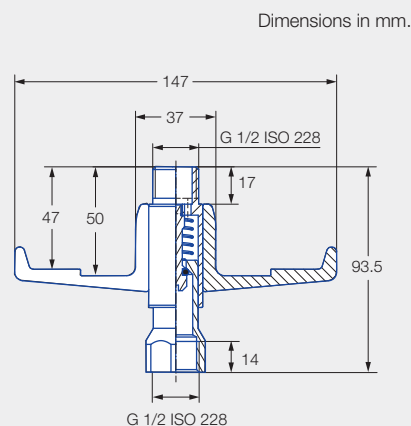

Advantages of dead man's circuit

- Valve is simple and convenient to operate
- Safety valve opens only in the event of container pressure
- Can be combined with static and rotating tank cleaning nozzles
- Versatile suitability for internal cleaning of all common canisters, containers and plant protection product packaging



Dead man's circuit

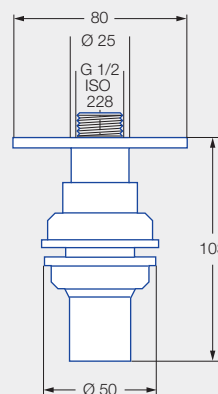

Technical data:



Materials
Stainless steel, POM



Pressure ranges
2–5 bar
Pressure > 5 bar:
Use orifice for
pressure reduction



Width across flats
CleanerValve
hex dia. 27 mm

Designation	Material	Order No.
CleanerValve	Stainless steel	092.175.17.01.00
Dead man's circuit	POM	A.510.100.00



Static spray ball 540/541



- Static multichannel solid jet nozzle

Advantages

- Ideal for rinsing containers
- Compact design
- Self-draining
- No moving parts and thus faultfree
- Easy to inspect

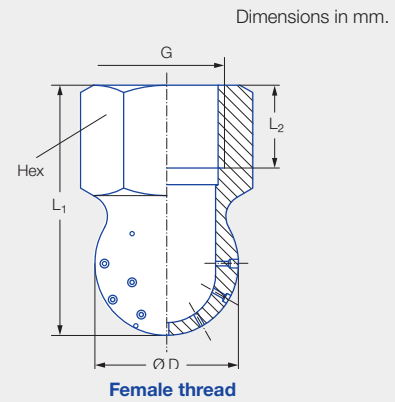
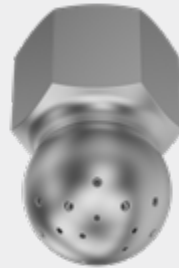

Series 540/541

Technical data:



Spray angle
240°



Materials
Solid stainless steel, PVC



Pressure ranges
2–3–10 bar



Operating principle
Static



Installation
Operation in every
installation position



Max. tank diameter
7.5 m

Spray angle	Order No.	V̇ water [l/min]					Max. tank diameter [m]
		2.0 bar	3.0 bar	4.0 bar	5.0 bar	10.0 bar	
240° 	540.909.16¹	18.0	22.0	25.4	28.5	40.2	6.5
	540.989.16¹	28.0	34.3	39.6	44.3	62.6	7.0
	541.109.16	57.0	69.8	80.6	90.1	127.5	7.5

¹ Also available in PVC.

Rotating cleaners

ContiCleaner with slide bearing and MicroWhirly



- Rotating cleaning head with flat spray nozzles and slide bearings

Advantages of ContiCleaner

- Optimized for continuous internal cleaning
- Color-coded in accordance with ISO 10625 in sizes 12, 25, 30 and 60
- Starts up reliably even at low pressure
- Suitable for all sprayers

Advantages of MicroWhirly

- Effective rotating cleaning by means of flat spray nozzles
- Optimum internal cleaning of plant protection equipment tanks, canisters, containers and plant protection product packaging
- Self-powered, without external drive
- Robust design
- Resistant to chemicals



ATEX version on request



ContiCleaner



MicroWhirly

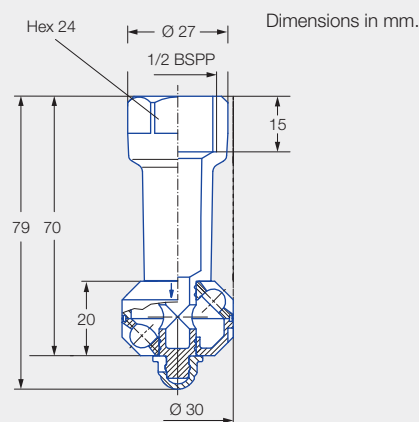

Female thread

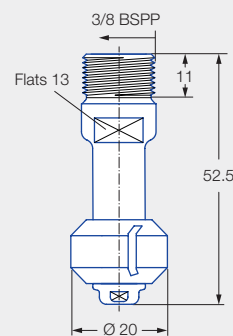

Male thread



Technical data:



Spray angle
360°



Materials
PVDF, PTFE, stainless steel



Pressure ranges
2–5 bar



Operating principle
Free-spinning



Installation
Operation in every installation position



Max. tank diameter
ContiCleaner: 1.6 m
Type 566: 1.7 m



Pre-filtering
Line strainer with a mesh size 0.3 mm/50



Bearing
Slide bearing

Function video
www.lechler.com/de-en/medialibrary
Or simply scan the QR code.



Spray angle	Designation	Order No.			V̇ Wasser [l/min]			Max. tank diameter [m]
		Material			p [bar] (p _{max} = 7 bar)			
		AISI 316L	PVDF	PTFE and PVDF	2.0 bar	3.0 bar	5.0 bar	
360° 	ContiCleaner 12 (60 M)	500.191.55.12.00		●	4.1	5.0	6.5	1.6
	ContiCleaner 25 (60 M)	500.191.55.25.00		●	8.2	10.0	12.9	1.6
	ContiCleaner 30 (60 M)	500.191.55.33.00		●	9.8	12.0	15.5	1.6
	ContiCleaner 60 (25 M)	500.191.55.60.00		●	20.4	25.0	32.3	1.6
	MicroWhirly stainless steel (25 M)	566.939.1Y.AE	●		21.0	26.0	33.6	1.7
	MicroWhirly PVDF (25 M)	500.191.5E.00		●	20.0	24.0	31.0	1.1

Rotating cleaners

CanCleaner und MiniWhirly



- Rotating cleaning head with flat spray nozzles and ball bearings

Advantages

- Effective rotating cleaning by means of flat spray nozzles
- Optimum internal cleaning of plant protection equipment tanks, canisters, containers and plant protection product packaging
- Self-powered, without external drive
- Slow rotation for optimum cleaning effect
- Resistant to chemicals



CanCleaner



MiniWhirly

Dimensions in mm.

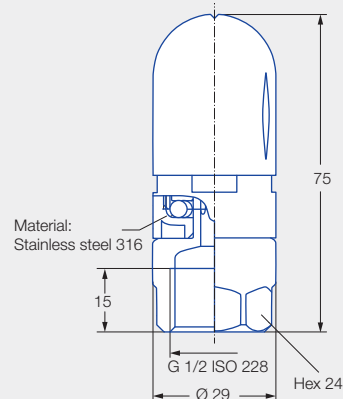

CanCleaner

- Even more effective cleaning due to 20 % higher flow rate towards canister bottom
- Color-coded in accordance with ISO 10625, in size 60

CanCleaner/MiniWhirly

Technical data:



Spray angle
300°



Materials
POM, stainless steel



Pressure ranges
2–3–5 bar



Operating principle
Free-spinning



Max. tank diameter
1,3 m



Pre-filtering
Line strainer with a mesh size 0.3 mm/50



Bearing
Ball bearing made of stainless steel

Function video
www.lechler.com/de-en/medialibrary

Or simply scan the QR code.



Spray angle	Designation	Order No.	V̇ water [l/min]				Max. tank diameter [m]
			2.0 bar	3.0 bar	4.0 bar	5.0 bar	
300° 	CanCleaner 60 (25 M)	500.186.56.06.00	20.4	25.0	28.9	32.3	1.3
	MiniWhirly (25 M)	500.186.56.AH	18.0	22.0	25.4	28.4	1.3

Rotating cleaner MiniSpinner 2 5M3



- Rotating cleaning head with flat spray nozzles and double ball bearings

Advantages

- Hygienic design
- Suitable for high temperatures
- Made completely of stainless steel



**ATEX version
on request**

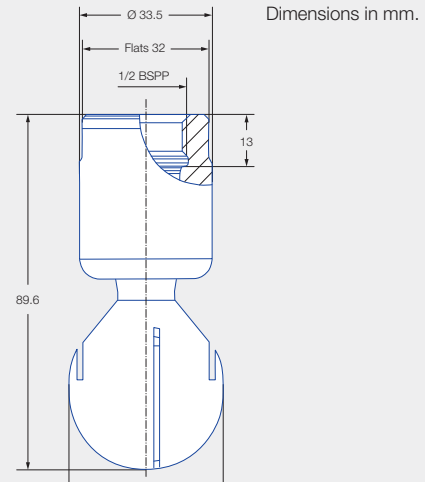

Series 5M3

Technical data:



Spray angle
360°



Material
Stainless steel 1.4404 (316L)



Pressure ranges
1–2–3 bar



Operating principle
Free-spinning



Installation
Operation in every
installation position



Max. tank diameter
2.3 m



Pre-filtering
Line strainer with
mesh size 0.1 mm/170



Bearing
Double ball bearing made
of stainless steel 1.4404
(316L)



**Cleaning
efficiency class**
2



Adapter
G 1/2 ISO 228 and
G 3/4 ISO 228 is
compatible with HygienicFit



Max. temperature
250 °C

Function video
www.lechler.com/de-en/medialibrary
Or simply scan the QR code.



Spray angle	Order No.				Narrowest cross-section Ø [mm]	V̇ water [l/min]				Max. tank diameter [m]
	Type	Connection				p [bar] (p _{max} = 7 bar)				
		G 1/2 ISO 228	G 3/4 ISO 228	3/4" plug connection		1.0	2.0	3.0	at 40 psi [US gal/min]	
60° 	5M3.122.1Y	AH		TF07	2.6	45	63	77	20	–
180° 	5M3.133.1Y		AL	TF07	1.2	47	67	82	21	2.6
180° 	5M3.134.1Y		AL	TF07	1.3	47	67	82	21	2.6
360° 	5M3.999.1Y		AL	TF07	0.4	21	30	37	9	1.8
	5M3.089.1Y		AL	TF07	0.7	35	49	60	15	2.1
	5M3.139.1Y		AL	TF07	0.8	49	69	85	21	2.3
	5M3.209.1Y		AL	TF07	1.5	71	100	122	31	2.6

NPT threads, other plug connections and weld-on versions on request.

The maximum tank diameter shown above applies for the recommended operating pressure and is indicative only. The type of soiling is also decisive for the cleaning result.

Compressed air can be used only for a short time for blowing dry. Use above the recommended pressure will have a negative effect on the cleaning result and wear.

Good to know

You can find detailed information in our brochure "Tank and equipment cleaning" and at www.lechler.com/de-en/tankcleaningnozzles

Ordering Type + Connection = Order No.
example: 5M3.999.1Y + AL = 5M3.999.1Y.AL

➤➤ ACCESSORY RANGE
IN DETAIL

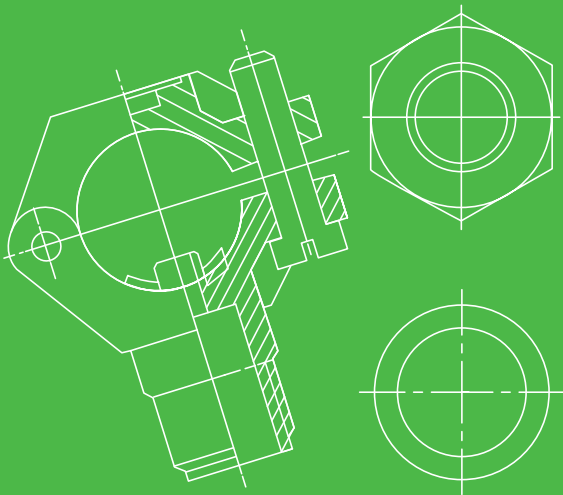





- Electrical Stop Valve, for individual nozzle control

Advantages

- Energy storage device with boost and buck mode (patented)
- More precise application due to individual nozzle control
- Ability to communicate with ISOBUS
- Retrofitting possible due to simple cabling
- Very robust thanks to encapsulated electronics and ventilation in the valve
- Extremely energy-efficient due to charge controller and super-capacitor



Electrical Stop Valve:
greater precision and cost savings
due to reduced overlap

Technical data:



Total power consumption
Max. 120 mA



Emergency-stop function
For input voltage < 8 V



Valve switching time
Opening: 0.3 s
Closing: 0.45 s



Protection class
IP 65



Materials
PA, POM, Viton,
PTFE, stainless steel



Pressure range
Max. 8 bar

Designation	Order No.
Valve, inside (black)	065.288.00.00.00
Valve, outside (gray)	065.288.00.01.00
Terminating resistor	065.288.00.30.00
Adapter box	065.288.00.50.00
Adapter box for intermediate power supply	065.288.00.51.00
Extension cable 2.5 m	065.288.00.20.00

Individual nozzle control with the ESV

Section widths of 50 cm to 25 cm possible.
Comparison of overlap with 3 m and 0.5 m section widths.

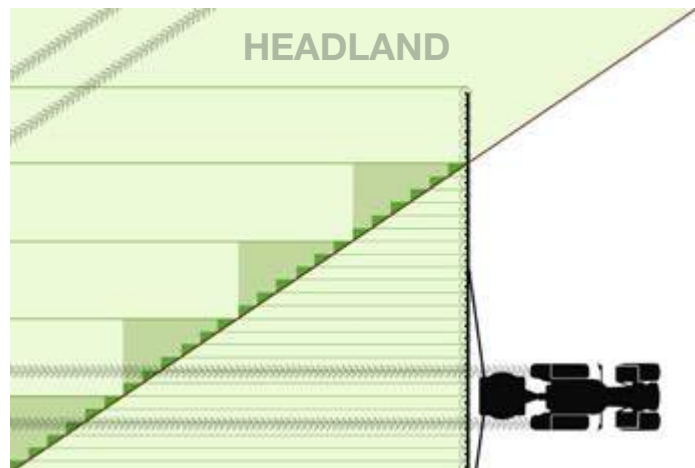

- = treated once
- = overlap with 3 m section widths
- = overlap with ESV

PSV (Pneumatic Stop Valve)



- Pneumatic Stop Valve pre-assembled on single nozzle holder

Advantages

- Continuous field spray line design as ring line with circulation and return
- Spray pressure is held in the spray line when nozzles are closed
- Immediate spray jet build-up at all nozzles after opening the pneumatic stop valves
- Simpler boom design since no section valves are required
- Rotating pneumatic connector facilitates assembly and routing of the air pressure line in the boom



Single nozzle holder with Pneumatic Stop Valve and standard pneumatic connection

Technical data:



Materials
PA, POM, Viton,
PTFE, stainless steel



Pressure range
Max. 8 bar,
air pressure min.
4.5 bar



Emergency-stop function
At air pressure below
4.5 bar



Valve switching time
0.2 s

Order No.										
Series	Pipe diameter					Pneumatic quick-action connectors (optional)				
	20 mm	1/2"	25 mm	3/4"	1"	Standard	90°	Straight	T	Y
065.282.56	20	21	25	27	34	0B	0A	0S	0T	0Y

Note

Oil is required in the pneumatic system for problem-free PSV operation.

Ordering Series + Pipe diameter + Pneumatic quick-action connector = Order No.
example: 065.282.56 + 1/2" + 90° = 065.282.56.21.0A



- 4-way nozzle holder V4 or 2-way nozzle holder V2 with pneumatic actuation for variable application rate control

Advantages

- Operation optionally in "Vario" or "Select" mode
 - Vario: Fully-automatic control of nozzles/nozzle combination and continuously variable adaptation of the application rate and pressure
 - Select: Manual activation and deactivation of individual nozzles/nozzle combinations
- V4 in modular design
- V2 in new more compact design with proven PSV valve technology (see Page 119)
- Single valve located directly in front of the nozzle
- Central liquid supply



VarioSelect
4-way nozzle holder
(pneumatic quick-action connectors optional)



VarioSelect II
2-way nozzle holder
(pneumatic quick-action connectors optional)

Technical data:



Materials
POM, POM fiber glass reinforced, EPDM, Viton, FPM, stainless steel



Pressure range
Max. 8 bar



Emergency-stop function
At air pressure below 4.5 bar



Valve switching time
0.2 s

Order No.													
Baureihe					Pipe diameter					Pneumatic quick-action connectors (optional)			
					20 mm	25 mm	1/2", 22 mm	3/4"	1"	Standard	90°	Y	
V4	065.286	MN	TN	MD	TD	20	25	21	27	34	B0	A0	Y0
V2	065.284.56					20	25	21	27	34	0B	0A	0Y

4-way nozzle holder V4

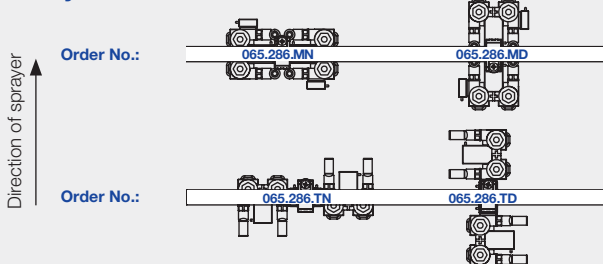

Main dimensions of 4-way nozzle

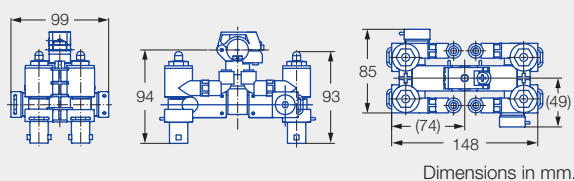

2-way nozzle holder V2

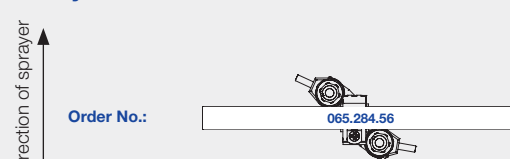



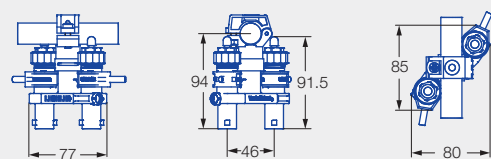



Main dimensions of 2-way nozzle

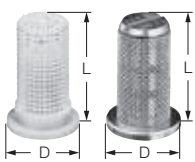

Ordering	Series	+ Pipe diameter	+ Pneumatic quick-action connector	= Order No.
example:	V4	+ 3/4"	+ 90°	= 065.286.MN.27.A0
	V2	+ 1/2"	+ Y	= 065.284.56.21.0Y

Ball check valves and nozzle strainers



Designation		Opening pressure [bar]	Mesh size	D [mm]	L [mm]	Material	Strainer area (without gaskets)	Order No.
Ball check valves¹		0.5	25 M	14.8	21.5	POM	628 mm ²	065.266.56.00
		0.5	60 M	14.8	21.5	POM	628 mm ²	065.265.56.00
		0.5	25 M	14.8	21.0	Brass	430 mm ²	065.261.30.00
		0.5	60 M	14.8	21.0	Brass	430 mm ²	065.260.30.00
		2.5	25 M	14.8	21.5	POM	628 mm ²	065.266.56.02
		2.5	60 M	14.8	21.5	POM	628 mm ²	065.265.56.02
Ball check valve (without strainer)		0.5		14.8	18.5	POM	–	065.266.56.01
Nozzle strainers¹		–	25 M	14.8	21.5	POM	628 mm ²	065.256.56.00
		–	60 M	14.8	21.5	POM	628 mm ²	065.257.56.00
		–	80 M	14.8	21.5	POM	430 mm ²	A.424.310.5
Slotted strainer		–	25 M	14.8	21.0	POM	430 mm ²	095.009.56.13.43
Cup strainers		–	25 M	14.8	8.5	Cu/Monel	184 mm ²	065.252.26.00
		–	25 M	14.8	8.5	PA/Monel	184 mm ²	200.029.26.00.03
		–	60 M	14.8	8.5	PA/Stainless	184 mm ²	200.029.1C.01.03
Nozzle strainers with integrated seal, for TWISTLOC		–	25 M	18.0	19.2	POM, Santoprene	628 mm ²	065.269.7J
		–	60 M	18.0	19.2	POM, Santoprene	628 mm ²	065.268.7J
Nozzle strainer with integrated seal, for MULTIJET		–	60 M	18.8	19.2	POM, Santoprene	628 mm ²	065.268.7J.10

¹ Important: Color coding for strainers and check valves according to ISO 19732:2007 (see Page 7).



- 3-nozzle fork for uniform spraying and penetration of row crops

Advantages

- Variable nozzle equipment, e.g. with twin (IDKT at top) and flat spray nozzles (IDK at sides)
- Uniform wetting and crop penetration at the sides and from above
- Flexible adaptation to individual crops by adjustable spray arms
- Robust, wear-resistant spray arm design in stainless steel
- Problem-free assembly on every spray boom



Dimensions in mm.

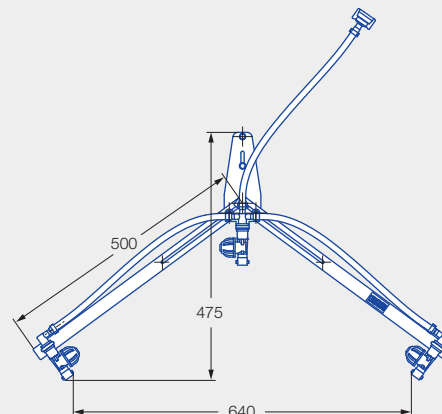

Application:



Plant protection products



Strawberries

Technical data:



Opening angle
Spray arms:
55°–107°



Materials
Stainless steel, PA



Pressure range
Max. 8 bar

Calculation example

1.000 l/ha, 4 km/h, row spacing 0.9 m

The **total nozzle output** of a spray frame for area treatment:

$$\frac{1.000 \text{ (l/ha)} \times 4 \text{ (km/h)} \times 0.9 \text{ (m)}}{600} = 6.0 \text{ l/min}$$

With three nozzles of the same size/series, the flow rate per nozzle is as follows:

$$6.0 \text{ l/min} : 3 = 2.0 \text{ l/min}$$

Recommendation

IDKT 05 (top) at 3.0 bar

IDKS 80-06 (lateral) at 3.0 bar

Order No. 092.165.00

Scope of delivery: spray frame without nozzles, nozzle strainer, gaskets and bayonet caps



- Underleaf spraying system for broadcast and row applications

Advantages

- Fits all booms
- Gentle on plants since hangs freely at right angles to plant row
- Less weather-dependent use due to low-drift application on crop
- Optimum plant protection product deposition at the sides and from below on leaf undersides and stalks
- Variable nozzle equipment with plant protection and liquid fertilizer nozzles
- Robust, light and flexible – only approx. 400 g

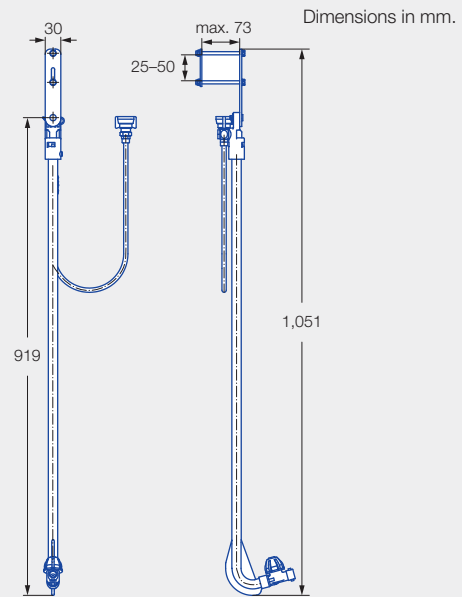
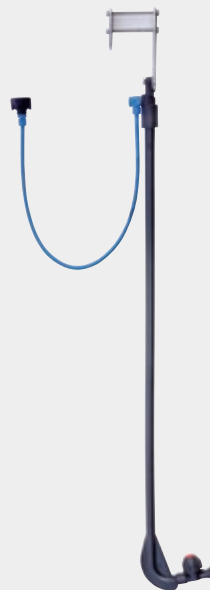

G 1994

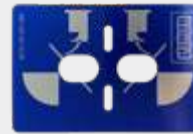

Adjustment template
Order No. **092.163.42.10.30**

- Nozzle equipment with:
- FT 140/FT 90, IDKT, DF, FL, TwinSprayCap
 - ID-120
 - IDK 120/IDK 90 / IDKN 120
 - LU 120/LU 90
 - FT 140/FT 90

Application:



Plant protection products and growth regulators



Vegetable growing



Liquid fertilizer delivery

Technical data:



Materials
POM fiber glass reinforced, PP, PA, stainless steel



Pressure range
Max. 8 bar



Nozzle calculator app



Description		Order No.
TwinSprayCap , MULTIJET system, for flood nozzles		092.163.56.10
Nozzle strainer 60 M		065.257.56.00
MULTIJET Y connector¹ 45° forward angling of nozzle		Y.823.001.80.00.00
MULTIJET bayonet cap 1/4" NPT female		A.402.910.01
Double nipple G 1/4 male		095.019.30.00.42
Double swivel nozzle holder G 1/4 female ¹ Freely adjustable nozzle position		A.404.172
Y-kit for row application		092.176.00.00.00

For further application information, see Page 69.

Order No. 092.171.56.00

Scope of delivery: pre-assembled without nozzles, nozzle strainer, gaskets and bayonet cap

¹ For standard + Dropleg^{UL} application.



MULTIJET, MultiCap

Nozzle holders and bayonet caps



Nozzle holder	Designation	Material	Order No.
	5-way nozzle holder with diaphragm check valve with eyelet connector		
	for 1/2" pipes	Polyamide (PA)	A.406.494.7
	for 3/4" pipes	Polyamide (PA)	A.406.495.7
	for 1" pipes	Polyamide (PA)	A.406.496.7
	4-way nozzle holder with diaphragm check valve with eyelet connector		
	for 20 mm pipes	Polyamide (PA)	A.406.472.71
	for 1/2" pipes	Polyamide (PA)	A.406.474.7
	for 3/4" pipes	Polyamide (PA)	A.406.475.7
	3-way nozzle holder with diaphragm check valve with eyelet connector		
	for 20 mm pipes	Polyamide (PA)	A.406.422.71
	for 1/2" pipes	Polyamide (PA)	A.406.424.7
	for 3/4" pipes	Polyamide (PA)	A.406.425.7
	3-way nozzle holder with diaphragm check valve with eyelet connector		
	for 1/2" pipes	Polyamide (PA)	A.401.274.7
	for 3/4" pipes	Polyamide (PA)	A.401.275.7
	for 1" pipes	Polyamide (PA)	A.401.276.7
	Single nozzle holder with diaphragm check valve with eyelet connector		
	for 20 mm pipes	Polyamide (PA)	A.402.725
	for 1/2" pipes	Polyamide (PA)	A.402.745
	for 25 mm pipes	Polyamide (PA)	A.402.75A.5
	for 3/4" pipes	Polyamide (PA)	A.402.755
	for 1" pipes	Polyamide (PA)	A.402.765



Technical data:



Materials
Stainless steel, PA



Pipe diameter in mm:



1/2"	21 mm
3/4"	27 mm
1"	34 mm

MultiCap fiber glass reinforced	Designation	Color code	Order No.
On request completely assembled with IDK/IDKN/IDKT   MultiCap with IDK nozzle Standard bayonet cap with IDK nozzle	Bayonet cap with SW 8 <ul style="list-style-type: none"> Suitable for MULTIJET bayonet system incl. gasket (A.402.200.04) POM fiber glass reinforced Long side optimally fixes IDK/IDKN/IDKS/IDKT nozzles Best possible protection of nozzle against damage and breakage Smaller exposed area at the side of the nozzle Optimum nozzle fit and alignment 	yellow	092.164.56.10.00
		lavender	092.164.56.20.00
		blue	092.164.56.30.00
		red	092.164.56.40.00
		brown	092.164.56.50.00
		black	092.164.56.60.00

MULTIJET and non-Lechler origin Bayonet caps and adapters

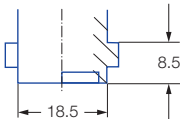

MULTIJET	Designation		Color code	Order No.
  Labeling on request.	Bayonet cap incl. gasket Y.G00.002.02.0 for combination with MULTIJET system, for example:   Dimensions in mm.	Combi cap for nozzles with 8 and 10 mm AF ID, IDK, IDKN, IDKT, AD, QS, LU, ST, DF, IS, IDKS, OC, E, FL, FS	red	Y.825.3C0.00.00.00.0
			blue	Y.825.3C0.00.30.00.0
			yellow	Y.825.3C0.00.10.00.0
			lavender	Y.825.3C0.00.80.00.0
			green	Y.825.3C0.00.20.00.0
			brown	Y.825.3C0.00.70.00.0
			black	Y.825.3C0.00.40.00.0
			gray	Y.825.3C0.00.90.00.0
			white	Y.825.3C0.00.50.00.0
			Fiber glass reinforced version	
AF 8	black	A.402.900.01.A		
AF 10	black	A.402.902.01.A		
for hollow cone nozzles TR, ITR, FT, BN hose shanks	black	A.402.904.10		
for flood nozzles FT	blue	A.402.908.4		
Bayonet cap 1/4" NPT female	black	A.402.910.01		
Shut-off cap	black	A.402.909		

Non-Lechler origin	Designation		Color code	Order No.
Bayonet cap Type H 	System: – Hardi incl. gasket (8/10 mm AF: 095.015.73.06.36)	Combi cap for nozzles with 8 and 10 mm AF ID, IDK, IDKN, IDKT, AD, QS, LU, ST, DF, IS, IDKS, OC, E, FL, FS	black	090.078.56.00.40.1
	Molded gasket (in combination with nozzle strainer 065.256.56 or 065.257.56 , see Page 121)			
Bayonet cap Type R 	System: – Rau incl. gasket (095.015.73.04.61) from year of manufacture 2000 See bayonet cap MULTIJET above	for nozzles with size 8 mm AF IDK, IDKN, IDKT, AD, QS, LU, ST, IDKS, OC, E	red	095.016.56.05.90
		for nozzles with size 10 mm AF ID, DF, IS, FL, FS	lavender	095.016.56.05.97

Intermediate and extension adapter

				
Intermediate adapter¹			Extension adapter and bayonet nipple¹	
Lechler TWISTLOC system 092.163.56.00.22.1 Extension: 22 mm	Rau system 092.163.56.00.21.0 Extension: 20 mm	Hardi system 092.163.56.00.20.1 Extension: 17 mm	MULTIJET system 092.163.56.00.23.1 Extension: 32 mm	MULTIJET bayonet nipple 092.163.56.00.26.0 see Page 133

¹ Including gasket.



- Quick-change nozzle system (max. operating pressure 20.0 bar)

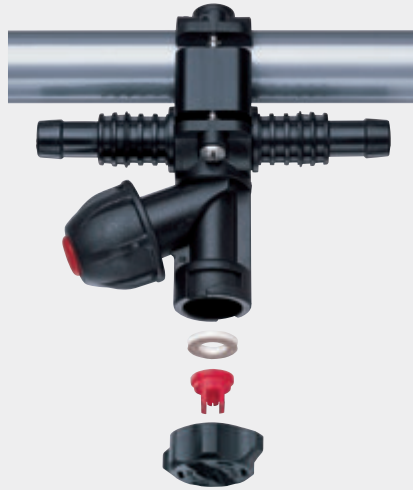

Diaphragm check valve for hose connection



Diaphragm check valve for installation on pipelines



Diaphragm check valve with eyelet connector
For 3/4" pipes
065.272.56.KL
For 1/2" pipes
065.272.56.KH



Diaphragm check valve with threaded connection
M 18 x 1.5
065.272.56.HB



Hose connection single
For pipe outside dia. 3/4" (25–28 mm O.D.)
065.274.56.KL
For pipe outside dia. 1/2" (20–22 mm O.D.)
065.274.56.KH



Hose connection double
For pipe outside dia. 3/4" (25–28 mm O.D.)
065.275.56.KL
For pipe outside dia. 1/2" (20–22 mm O.D.)
065.275.56.KH

Nozzle strainer with molded gasket
60 M
065.268.7J (Page 121)
25 M
065.269.7J (Page 121)



Eyelet clamp
For 1" pipes
090.023.51.KA
For 3/4" pipes
090.013.51.KA
For 1/2" pipes
090.003.51.KA



Bayonet adapter with threaded connection
M 18 x 1.5
095.009.00.07.98



Ball check valve
Mesh size 60 M:
065.265.56.00
Mesh size 25 M:
065.266.56.00



Bayonet cap
Overview on Page 127



Gasket
065.242.73



TWISTLOC Bayonet caps and solenoid valves



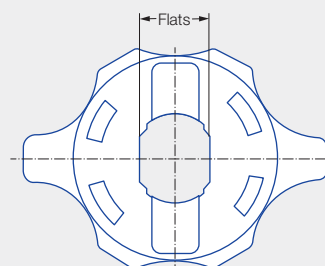

Advantages

- Simple handling
- Ergonomic shape



TWISTLOC	Designation	Color code	Order No.
(incl. gasket 065.242.73.00) for combination with following systems ¹ : <ul style="list-style-type: none"> • Lechler • Holder • Amazone • Schmotzer • Brendecke • Vogel & Noot 	for nozzles with 8 mm AF IDK, IDKN, IDKT, AD, QS, LU, ST, IDKS, OC, E	white	065.204.56.05
	for nozzles with 8 and 10 mm AF ID, IDK, IDKN, IDKT, AD, QS, LU, ST, DF, IS, IDKS, OC, E, FL, FS	brown	065.204.56.06
		red	065.202.56.00
		black	065.202.56.01
		yellow	065.202.56.02
		green	065.202.56.03
		blue	065.202.56.04
		gray	065.202.53.00
Round-hole bayonet cap (incl. gasket 065.242.73.00)	for TR, ITR, FT, BN hose shank	black	065.202.56.11
	for FT	dark-gray	065.202.56.50
Shut-off cap (incl. gasket 095.015.6C.02.85.0)		beige	065.202.56.40

Solenoid valve	Designation	Maximum pressure [bar]	Order No.
	Solenoid valve for TWISTLOC and MULTIJET nozzle holders GDM 3-pin plug connection according to DIN 43650, power consumption: 0.8 A Tightening torque at nozzle holder: 2.5 Nm	8.0	065.277.56.00.00.0
	Solenoid valve for hose connection, power consumption: 0.5 A Hose dia. 10.0 mm	10.0	Z-Endvalve 10
	Hose dia. 13.0 mm	10.0	Z-Endvalve 00
	Spare part piston		Z-E06011.00

¹ Depending on series/type.

Eyelet connectors

Ball joints/swivel nozzle holders



Eyelet connectors



Designation	Pipe dia.	Thread G	B [mm]	L [mm]	Material	Order No.
Eyelet connector, single, max. 10 bar, with stainless-steel screw	3/8"	G 3/8 male	41	49	Polyamide	090.053.51
	1/2"	G 3/8 male	45	53	Polyamide	090.003.51
	3/4"	G 3/8 male	51	57	Polyamide	090.013.51
	1"	G 3/8 male	61	65	Polyamide	090.023.51

Ball joints

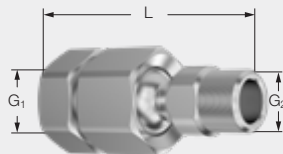

Designation	Thread G ₁	Thread G ₂	L [mm]	Material	Order No.
Ball joint with threaded connection max. 25 bar, full-swivel type max. 30°	G 3/8 female	G 3/8 male	56	Brass	092.022.30 AF
	G 1/2 female	G 1/2 female	71	Brass	092.040.30 AH
	G 3/4 female	G 3/4 female	80	Brass	092.050.30 AL

Swivel nozzle holders

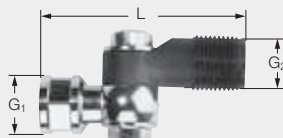

Accessories for swivel nozzle



Designation	Thread G ₁	Thread G ₂	L [mm]	Material	Accessories	Order No.
Swivel nozzle holder max. 20 bar, swivel function in one plane	G 1/4 male	G 3/8 male	35	Polyamide		095.016.56.07.22
	1/4" NPT female	G 3/8 male	35	Polyamide		095.016.56.07.21
				POM	incl. threaded cap G 3/8	065.200.56
				Rubber	incl. gasket	065.240.73.00

Double swivel nozzle holders

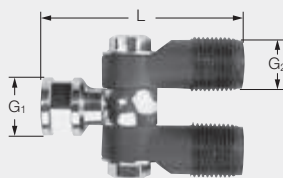

Accessories for double swivel

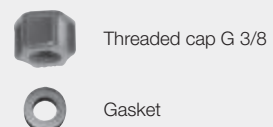

Designation	Thread G ₁	Thread G ₂	L [mm]	Material	Accessories	Order No.
Double swivel nozzle holder max. 20 bar	1/4" NPT female	G 3/8 male	35	Polyamide		095.016.56.07.20
				POM	incl. threaded cap G 3/8	065.200.56
				Rubber	incl. gasket	065.240.73.00



CleanerFix

- For tank installation from outside
- Suitable for ContiCleaner and other cleaning nozzles



CleanerFix



Extension

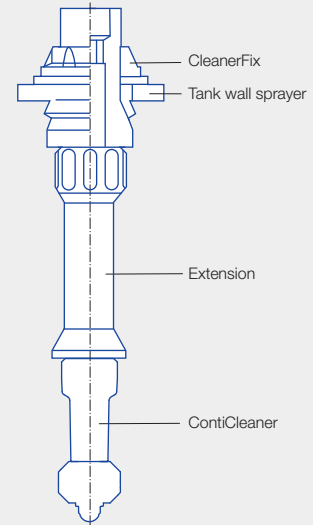

CleanerFix	Order No.
For installation of cleaning nozzles without entering the tank.	050.050.56.00.00.0
For simple, fast and safe exchange of cleaning nozzles in the tank.	
Extension for CleanerFix approx. 9.5 cm	050.050.53.10.00

For more information on the ContiCleaner, see Page 113.

Installation

Installation can be performed in just a few simple steps. Our video instructions show the individual steps.

Installation video
www.lechler.com/de-en/medialibrary
 Or simply scan the QR code.



Diaphragm nozzle holder for air-assisted sprayers, Assembly accessories, Relocation kit

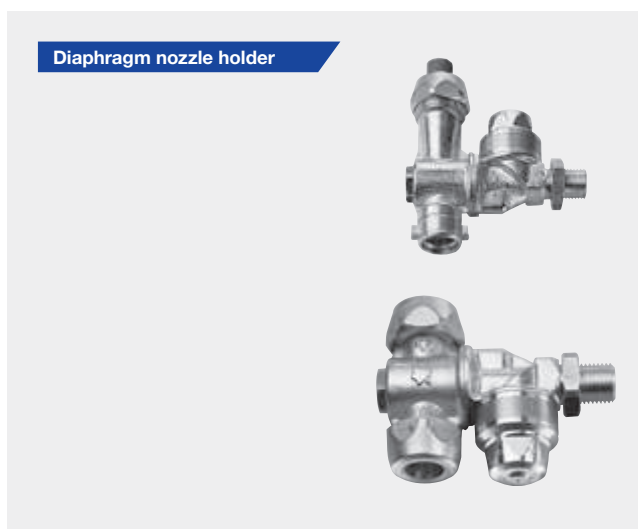

Designation	Material	Order No.
Bayonet diaphragm nozzle holder incl. threaded cap and bayonet cap Opening pressure: 0.7 bar Closing pressure: 0.7 bar Max. working pressure: 25 bar		
G 1/4 male	Brass	Z.TRA.EGE.RK.OM.B
Diaphragm nozzle holder incl. 2 threaded caps Opening pressure: 1.1 bar Closing pressure: 0.9 bar Max. working pressure: 40 bar		
G 1/4 male	Brass	095.016.30.09.61.0
G 1/4 female	Brass	095.016.30.09.62.0



Designation	Material	Order No.
Reduction socket M 18 x 1,5 female / G 1/4 female	Brass	095.016.30.12.80.0
Reduction socket G 3/8 female / G 1/4 female	Brass	095.019.30.00.23
Reduction coupling G 3/8 male / G 1/4 female	Brass	065.221.30



Description	Order No.
Variable row adaptation (e.g. corn 0.75 m row spacing) with relocation kit Installation on wet boom 1/2" (20–22 mm) 3/4" (25–28 mm) on request	092.174.00.00.00.0

Good to know

You can find further information and our assembly instructions here:
www.lechler.com/de-en/support



➤ Sockets

Double nipples

Threaded caps



Sockets

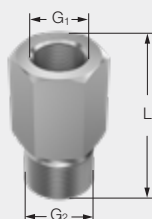

G ₁	G ₂	L [mm]	Material	Order No.
G 1/8 female	G 3/8 male	20	Brass	040.211.30
G 1/4 female	G 3/8 male	23	Brass	065.221.30
G 1/4 female	G 3/8 male	36 ¹	Brass	065.228.30.00.00.1
G 3/8 female	G 3/8 male	28	Brass	065.220.30
M 11 x 1 female	G 3/8 male	36 ¹	Brass	065.222.30
G 3/4 female	G 3/4 male	35	Brass	065.620.30
G 3/8 female	M 18 x 1.5 male	28	Galvanized	095.016.02.03.43

Double nipples

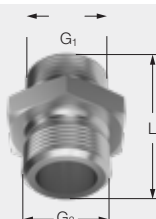

G ₁	G ₂	L [mm]	Material	Order No.
G 1/4 male	G 1/4 male	27	Brass	095.019.30.00.42
G 1/4 male	G 3/8 male	25	Brass	065.215.30
G 1/4 male	G 3/8 male	35 ¹	Brass	065.215.30.02
G 3/8 male	G 3/8 male	25	Brass	065.211.30
M 11 x 1 male	G 3/8 male	36 ¹	Brass	065.213.30
G 3/4 male	G 3/4 male	35	Brass	065.611.30

Reducing couplers

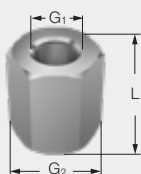

G ₁	G ₂	L [mm]	Material	Order No.
M 18 x 1.5 female	G 1/4 female	21	Brass	095.016.30.12.80
G 3/8 female	G 1/4 female	26	Brass	095.019.30.00.23

Threaded caps

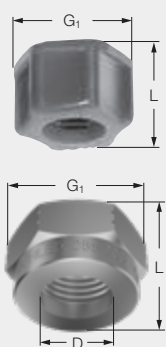

G ₁	D [mm]	L [mm]	AF [mm]	Material	Order No.
M 18 x 1.5 female	13.0	18	²	Polyamide	095.011.51.00.21
G 3/8 female	12.8	13	22	Stainless	065.200.16
G 3/8 female	12.8	13	22	Brass	065.200.30
G 3/8 female	12.8	13	22	POM	065.200.56
G 3/4 female	20.1	16	32	Brass	065.600.30
Gasket for threaded cap M 18 x 1.5 16 x 10 x 2.5				Rubber	090.020.73.00.03
Gasket for threaded cap 3/8" 11 x 15 x 1.6				Rubber	065.240.73
Gasket for threaded cap 3/4" 18 x 24 x 1.0				EWP	065.640.72

¹ Installation of nozzle strainers and ball check valves possible (see Page 121).

² Wing nut.



Hose shank

Suitable for threaded cap
065.200.XX (Page 131)
 or round-hole bayonet cap
065.202.56.11 (Page 127),
A.402.904.10 (Page 125)

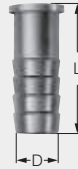

Maximum pressure [bar]	Hose dia. D [mm]	L [mm]	Material	Order No.
10	12	34	PA	095.016.56.07.49

Hose shanks with male thread



Thread	Maximum pressure [bar]	Hose dia. D [mm]	L [mm]	Material	Order No.
G 3/8	25	11	35	Brass	095.016.30.07.67
G 1/2	25	11	40	Brass	095.016.30.07.68
1/4" NPT	10	10	54	PP	BHB025038
3/8" NPT	10	13	66	PP	BHB038050
1/2" NPT	10	13	68	PP	BHB050
3/4" NPT	10	19	74	PP	BHB075
3/4" NPT	10	25	76	PP	BHB075100
1" NPT	10	25	80	PP	BHB100
1" NPT	10	32	90	PP	BHB100125
1 1/4" NPT	10	30	90	PP	BHB125
1 1/4" NPT	10	25	81	PP	BHB125100
1 1/2" NPT	10	37	104	PP	BHB150
2" NPT	10	36	107	PP	BHB200150
2" NPT	10	49	115	PP	BHB200
G 2	6	60	134	PVC	095.016.50.05.73
3" NPT	10	75	160	PP	BHB300

**Hose shanks
with 90° angle**

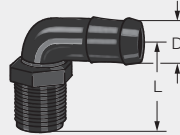

Thread	Maximum pressure [bar]	Hose dia. D [mm]	L [mm]	Material	Order No.
1/4" NPT	10	6	35	PP	BHB02590
3/8" NPT	10	10	36	PP	BHB03890
1/2" NPT	10	10	36	PP	BHB05003890
1/2" NPT	10	12	38	PP	BHB05090
1/2" NPT	10	20	41	PP	BHB05007590
3/4" NPT	10	12	42	PP	BHB07505090
3/4" NPT	10	20	45	PP	BHB07590
3/4" NPT	10	25	48	PP	BHB07510090
1" NPT	10	20	50	PP	BHB10007590
1" NPT	10	25	53	PP	BHB10090
1" NPT	10	32	56	PP	BHB10012590
1 1/4" NPT	10	25	53	PP	BHB12510090
1 1/4" NPT	10	32	56	PP	BHB12590
1 1/2" NPT	10	40	63	PP	BHB15090
2" NPT	10	50	64	PP	BHB20090
3" NPT	10	75	113	PP	BHB30090

**Hose shanks
with threaded cap**



Thread	Maximum pressure [bar]	Hose dia. D [mm]	L [mm]	Material	Order No.
G 1/2	25	11	42	Brass	095.016.30.06.41
G 1/2	25	13	42	Brass	095.016.30.06.42
G 1 1/4	10	30	77	PP	095.016.53.07.47
G 1 1/2	10	40	67	PP	095.016.53.07.48
G 2	6	50	70	PP	A.100.750

**MULTIJET
Bayonet nipple incl. gasket**

Suitable for ISO dosing orifices (see Page 93).

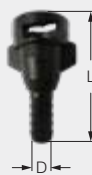

Maximum pressure [bar]	Hose dia. D [mm]	L [mm]	Material	Order No.
10	12	65	PP	092.163.56.00.26.0



Double nipples



Reducing couplers



Reducers



Taper nipples



Blanking plugs



Couplers



Connection/thread	Order No.
1/2" NPT male	BNIP050-SH
3/4" NPT male	BNIP075-SH
1" NPT male	BNIP100-SH
1 1/4" NPT male	BNIP125-SH
1 1/2" NPT male	BNIP150-SH
1 1/2" NPT male, Length: 4"	BNIP150-4
2" NPT male	BNIP200-SH
2" NPT male, Length: 4"	BNIP200-4
3" NPT male	BNIP300-SH
1/2" NPT male x 3/8" NPT female	BRB050-038
3/4" NPT male x 1/4" NPT female	BRB075-025
3/4" NPT male x 1/2" NPT female	BRB075-050
1" NPT male x 3/4" NPT female	BRB100-075
1 1/4" NPT male x 3/4" NPT female	BRB125-075
1 1/4" NPT male x 1" NPT female	BRB125-100
1 1/2" NPT male x 3/4" NPT female	BRB150-075
1 1/2" NPT male x 1" NPT female	BRB150-100
1 1/2" NPT male x 1 1/4" NPT female	BRB150-125
2" NPT male x 3/4" NPT female	BRB200-075
2" NPT male x 1" NPT female	BRB200-100
2" NPT male x 1 1/4" NPT female	BRB200-125
2" NPT male x 1 1/2" NPT female	BRB200-150
3" NPT male x 1 1/2" NPT female	BRB300-150
3" NPT male x 2" NPT female	BRB300-200
1" NPT female x 3/4" NPT female	BRC100-075
1 1/2" NPT female x 1" NPT female	BRC150-100
1 1/2" NPT female x 1 1/4" NPT female	BRC150-125
2" NPT female x 1" NPT female	BRC200-100
2" NPT female x 1 1/4" NPT female	BRC200-125
2" NPT female x 1 1/2" NPT female	BRC200-150
3" NPT female x 2" NPT female	BRC300-200
1/2" NPT male x 3/4" NPT male	BRN075-050
1/2" NPT male x 1" NPT male	BRN100-050
3/4" NPT male x 1" NPT male	BRN100-075
3/4" NPT male x 1 1/4" NPT male	BRN125-075
1" NPT male x 1 1/4" NPT male	BRN125-100
1" NPT male x 1 1/2" NPT male	BRN150-100
1 1/4" NPT male x 1 1/2" NPT male	BRN150-125
1 1/4" NPT male x 2" NPT male	BRN200-125
1 1/2" NPT male x 2" NPT male	BRN200-150
2" NPT male x 3" NPT male	BRN300-200
3/4" NPT male	BPLUG075
1" NPT male	BPLUG100
1 1/2" NPT male	BPLUG150
2" NPT male	BPLUG200
1/2" NPT female	BCPLG050
3/4" NPT female	BCPLG075
1" NPT female	BCPLG100
1 1/4" NPT female	BCPLG125
1 1/2" NPT female	BCPLG150
2" NPT female	BCPLG200
3" NPT female	BCPLG300

Tees



45° elbows



90° elbows



Crosses





Connection/thread	Order No.
3/8" NPT female	BTEE038
1/2" NPT female	BTEE050
3/4" NPT female	BTEE075
1" NPT female	BTEE100
1 1/4" NPT female	BTEE125
1 1/2" NPT female	BTEE150
2" NPT female	BTEE200
3" NPT female	BTEE300
3/4" NPT female x 3/4" NPT male	BSL075-45
1" NPT female x 1" NPT male	BSL100-45
1 1/4" NPT female x 1 1/4" NPT male	BSL125-45
1 1/2" NPT female x 1 1/2" NPT male	BSL150-45
2" NPT female x 2" NPT male	BSL200-45
3" NPT female x 3" NPT male	BSL300-45
3/8" NPT female x 3/8" NPT female	BEL038-90
1/2" NPT female x 1/2" NPT female	BEL050-90
3/4" NPT female x 3/4" NPT female	BEL075-90
1" NPT female x 1" NPT female	BEL100-90
1 1/4" NPT female x 1 1/4" NPT female	BEL125-90
1 1/2" NPT female x 1 1/2" NPT female	BEL150-90
2" NPT female x 2" NPT female	BEL200-90
3" NPT female x 3" NPT female	BEL300-90
3/8" NPT female x 3/8" NPT male	BSL038-90
1/2" NPT female x 1/2" NPT male	BSL050-90
3/4" NPT female x 3/4" NPT male	BSL075-90
1" NPT female x 1" NPT male	BSL100-90
1 1/4" NPT female x 1 1/4" NPT male	BSL125-90
1 1/2" NPT female x 1 1/2" NPT male	BSL150-90
2" NPT female x 2" NPT male	BSL200-90
3" NPT female x 3" NPT male	BSL300-90
3/4" NPT female	BCR075
1" NPT female	BCR100
1 1/4" NPT female	BCR125
1 1/2" NPT female	BCR150
2" NPT female	BCR200

See Page 15 for more information on thread table.
Other thread sizes on request.







Manifold flange system parts

Full port = full continuity corresponding to connection

	Designation	Connection/thread	Order No.
	Check valves	1"	BMCV100
		2", full port	BMCV220
		3", full port	BMCV 300
	Straight flanges	1" x 1" flange	BM100CPG
		2" x 2" full port flange	BM220CPG
		3" x 3" full port flange x 4" long	BM300CPG
		2" x 2" full port flange x 6" long	BM220CPG6
		3" x 3" full port flange x 7" long	BM300CPG7
	45° flanges	1" x 1" 45° flange	BM100CPG45
		2" x 2" 45° full port flange	BM220CPG45
		3" x 3" 45° full port flange	BM300CPG45
	90° flanges	1" x 1" 90° flange	BM100CPG90
		2" x 2" 90° full port flange	BM220CPG90
		3" x 3" 90° full port flange	BM2300CPG90
	90° flanges "Sweep", (10% more flow)	2" 90° full port flange "Sweep"	BM220SWP90
		3" 90° flange "Sweep"	BM300SWP90
	Flange reducer couplings	2" flange x 1" flange	BM200100CPG
		2" full port flange x 1" flange	BM220100CPG
		3" flange x 2" flange	BM300200CPG
		3" flange x 2" full port flange	BM300220CPG
	Flange tees	1"	BM100TEE
		2"	BM200TEE
		2" full port flange x 2"	BM220200TEE
		2" full port flange tee	BM220TEE
		3"	BM300TEE
	U-bolt (stainless steel)	100 series	BUB100
		200 series	BUB202
		220 series	BUB220
	Adapter, flange – BSP thread	1" flange x 1" BSP male	BM100BSP
		2" full port flange x 2" BSP male	BM220BSP
		3" full port flange x 3" BSP male	BM300BSP
	Adapter, flange – NPT thread	1" flange x 1" NPT male	BM100MPT
		2" flange x 1 1/2" NPT male	BM200150MPT
		2" full port flange x 2" NPT male	BM220MPT
		3" flange x 3" NPT male	BM300MPT
	Full porte	1" flange x 1" FIXLOC	BM100A
		2" full port flange x 2" FIXLOC	BM220A
		3" full port flange x 3" FIXLOC	BM300A
	Flanges – hose shank	1" flange x 3/4" hose	BM100075BR
		1" flange x 1" hose	BM100BRB
		2" flange x 1 1/2" hose	BM200150BRB
		2" full port flange x 1" hose	BM220100BR
		2" full port flange x 1 1/4" hose	BM220125BR
		2" full port flange x 1 1/2" hose	BM220150BR
		2" full port flange x 2" hose	BM220BRB
		3" flange x 2" hose	BM300220BR
		3" flange x 3" hose	BM300BRB

Full port = full continuity corresponding to connection

	Designation	Connection/thread	Order No.
	Flanges – 90° hose shank	1" flange x 3/4" hose	BM100075BRB90
		1" flange x 1" hose	BM100BRB90
		2" full port flange x 1 1/2" hose	BM220150BRB90
		2" full port flange x 2" hose	BM220BRB90
		3" flange x 2" hose	BM300220BRB90
3" flange x 3" hose		BM300BRB90	
	Flanges – 45° hose shank	1" flange x 1" hose	BM100BRB45
		2" full port flange x 2" hose	BM220BRB45
		3" flange x 3" hose	BM300BRB45
	Flange crosses	1" flange	BM100CR
		2" full port flange	BM220CR
		3" flange	BM300CR
	Flange clamps (stainless steel)	100 series	BFC100
		200 series	BFC200
		220 series (for full port)	BFC220
		300 series (for full port)	BFC300
	Flange gaskets (EPDM)	1" with rib	BM101G
		1 1/2"	B150G
		2" with rib	BM201G
		2" full port with rib	BM221G
		3" with rib	BM301G

Ball valves

Designation	Connection/thread	Maximum pressure [bar]	Opening	Order No.
2-way valves (bolted, full port)	1"	10	1"	BMV100CF
	2"	10	2"	BMV220CF
	3"	7	3"	BMV300CF
Compact "Stubby" 2-way valves (full port)	2" flange – FIXLOC male adapter	7	2"	BMVSF220FP
	2" flange – flange	7	2"	BMVS220CF
	3" flange – FIXLOC male adapter	7	3"	BMVSF300FP
	3" flange – flange	7	3"	BMVS300CFFP
3-way valves (bolted, full port)	2" connection at bottom	7	2"	BMV220BL
	2" connection at front (closing not possible)	7	2"	BMV220SL
	3" connection at bottom	7	3"	BMV300BL



- Lever coupling system with NPT and BSP threads (BS21 and DIN EN 10226)

Advantages



- Chemically resistant to agricultural chemicals and liquid fertilizers
- Corrosion-resistant stainless steel
- Easy handling
- Pressure:
 - 1/2"–2" max. 9.0 bar
 - 3" max. 5.0 bar



FIXLOC system parts



Designation	Connection	Order No.
Male adapter with female threads straight version	1/2" NPT female	B050-A-NPT
	3/4" NPT female	B075-A-NPT
	1" BSP female	B100-A-BSP
	1 1/4" NPT female	B125-A-NPT
	1 1/2" BSP female	B150-A-BSP
	2" BSP female	B200-A-BSP
	3" BSP female	B300-A-BSP
same but as 90° elbow	1 1/2" NPT female	B150-A 90°-NPT
	2" NPT female	B200-A 90°-NPT
Male adapter with male threads straight version	1/2" NPT male	B050-F-NPT
	3/4" NPT male	B075-F-NPT
	1" BSP male	B100-F-BSP
	1 1/4" NPT male	B125-F-NPT
	1 1/2" BSP male	B150-F-BSP
	2" BSP male	B200-F-BSP
	3" NPT male	B300-F-NPT
same but as 90° elbow	1 1/2" NPT male	B150-F 90°-NPT
	2" NPT male	B200-F 90°-NPT
Male adapter with hose shank	1/2"	B050-E
	3/4"	B075-E
	1"	B100-E
	1 1/4"	B125-E
	1 1/2"	B150-E
	2"	B200-E
Female coupler with female threads straight version	1/2" NPT female	B050-D-NPT
	3/4" NPT female	B075-D-NPT
	1" BSP female	B100-D-BSP
	1 1/4" NPT female	B125-D-NPT
	1 1/2" BSP female	B150-D-BSP
	2" BSP female	B200-D-BSP
	3" NPT female	B300-D-NPT
same but as 90° elbow	3" BSP female	B300-D-BSP
	1 1/2" NPT female	B150-D 90°-NPT
	2" NPT female	B200-D 90°-NPT

	Designation	Connection	Order No.
	Female coupler with male thread	1/2" NPT male	B050-B-NPT
		3/4" NPT male	B075-B-NPT
		1" BSP male	B100-B-BSP
		1 1/4" NPT male	B125-B-NPT
		1 1/2" BSP male	B150-B-BSP
		2" BSP male	B200-B-BSP
		3" NPT male	B300-B-NPT
		3" BSP male	B300-B-BSP
	Female coupler with hose shank straight version	1/2"	B050-C
		3/4"	B075-C
		1"	B100-C
		1 1/4"	B125-C
		1 1/2"	B150-C
		2"	B200-C
		3"	B300-C
	same but as 90° elbow	1 1/2"	B150-C 90°
		2"	B200-C 90°
		Plug for female coupler	1/2"
3/4"			B075-PL
1"			B100-PL
1 1/4"			B125-PL
1 1/2"			B150-PL
2"			B200-PL
3"			B300-PL
	Plug for male coupler	1/2"	B050-CAP
		3/4"	B075-CAP
		1"	B100-CAP
		1 1/4"	B125-CAP
		1 1/2"	B150-CAP
		2"	B200-CAP
		3"	B300-CAP
	Spare gasket for FIXLOC lever couplings EPDM	1/2"	B075-G
		3/4"	B075-G
		1"	B100-G
		1 1/4"	B100-G
		1 1/2"	B150-G
		2"	B200-G
		3"	B300-G

Note

The following coupling types are compatible: 125 (1 1/4") with 100 (1") and 75 (3/4") and 50 (1/2").
For thread table, see Page 15.



Pumps

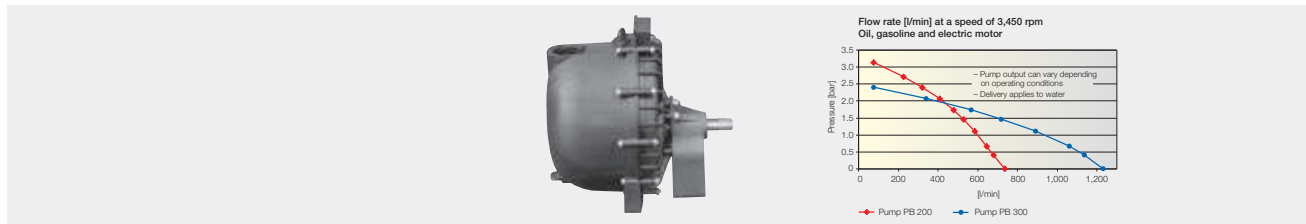

Description	Connection	Order No.
Pump PB 200 with base (excl. motor)	2" female	095.016.00.07.82
Pump PB 200 with three-phase a.c. motor	2" BSP female	095.016.00.08.02
Pump PB 200 with hydraulic motor	2" BSP female	095.016.00.08.01
Pump PB 200 with gasoline motor	2" female	095.016.00.07.81
Pump PB 300 with base (excl. motor)	3" BSP female	095.009.00.12.21
Pump PB 300 with three-phase a.c. motor	3" BSP female	095.009.00.12.20
Pump PB 300 with hydraulic motor	3" BSP female	095.009.00.12.22

Ball valves

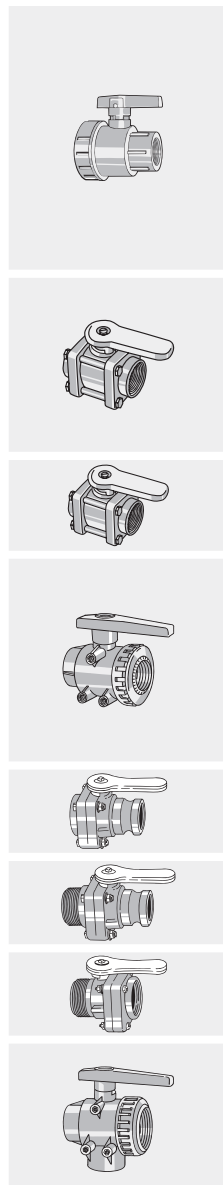
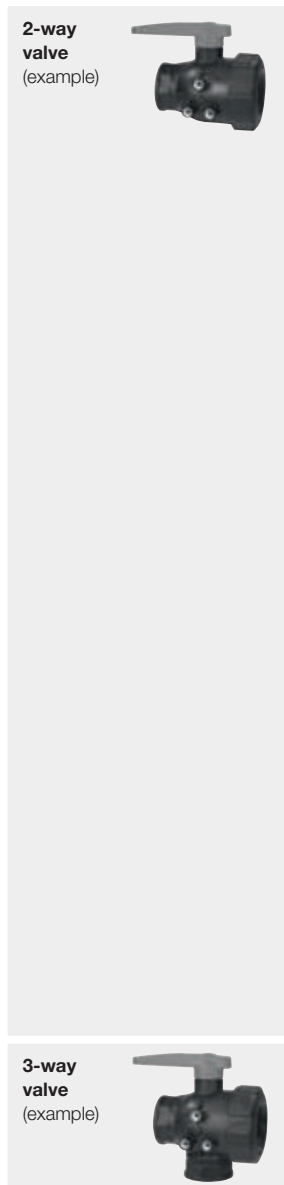

Type/Connector thread	Maximum pressure [bar]	Order No.
2-way valve with NPT threads		
1/2" NPT female	7	BUV050FP
3/4" NPT female	7	BUV075FP
1" NPT female	7	BUV100FP
1 1/4" NPT female	7	BUV125FP
1 1/2" NPT female	7	BUV150FP
2" NPT female	7	BUV200FP
2-way valve with NPT threads		
1/2" NPT female	10	BV050
3/4" NPT female	10	BV075
1" NPT female	10	BV100
1 1/2" NPT female	10	BV150
2" NPT female	10	BV200
2-way valve with BSP threads		
3" BSP female	7	BV300-BSP
3" BSP female	7	BV300FP-BSP
2-way valve with G threads		
G 1/2 female	16	A.454.132
G 3/4 female	16	A.454.133
G 1 female	16	A.454.134
G 1 1/4 female	10	A.454.135
G 1 1/2 female	10	A.454.136
G 2 female	10	A.454.137
2-way valve with 2" FIXLOC male adapter and 2" NPT female	7	BVSF200
2-way valve with 2" FIXLOC male adapter and 2" NPT male	7	BVSFMT200
2-way valve with 2" NPT male and 2" female	7	BVSMT200
3-way valve with G threads		
G 1 female	16	A.454.234
G 1 1/4 female	10	A.454.235
G 1 1/2 female	10	A.454.236
G 2 female	10	A.454.237





- Line strainers up to max. 14 bar
- Large-area strainer
- Strainer inserts color-coded in accordance with ISO 19732
- Mounting points on strainer housing

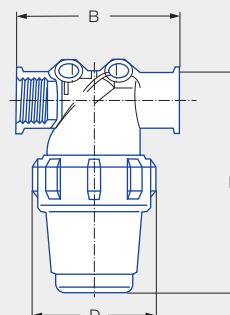

Line strainer

SGI female

(Incl. strainer insert 50 M, blue)



Max. flow rate [l/min]	Order No.	Connection	Dimensions [mm]			Order No. of strainer insert Mesh size ¹ color code			
			B	D	L	30 M	50 M	80 M	100 M
100	SGI 2	G 1/2 female	99	74	136	012.06	012.03	012.08	012.02
100	SGI 3	G 3/4 female	99	74	136	012.06	012.03	012.08	012.02
160	SGI 4	G 1 female	107	86	165	100.06	100.03	100.08	100.02
280	SGI 5	G 1 1/4 female	146	116	279	114.06	114.03	114.08	114.02
280	SGI 6	G 1 1/2 female	146	116	279	114.06	114.03	114.08	114.02

SGA male

(Incl. strainer insert 50 M, blue)



Max. flow rate [l/min]	Order No.	Connection	Dimensions [mm]			Order No. of strainer insert Mesh size ¹ color code			
			B	D	L	30 M	50 M	80 M	100 M
100	SGA 2	G 1/2 male	99	74	136	012.06	012.03	012.08	012.02
100	SGA 3	G 3/4 male	99	74	136	012.06	012.03	012.08	012.02
160	SGA 4	G 1 male	112	86	165	100.06	100.03	100.08	100.02
280	SGA 5	G 1 1/4 male	146	116	279	114.06	114.03	114.08	114.02
280	SGA 6	G 1 1/2 male	146	116	279	114.06	114.03	114.08	114.02

¹ Please always specify the desired mesh size when ordering!

SGI 6R

Version with additional connector for strainer cleaning



Max. flow rate [l/min]	Order No.	Connection	Dimensions [mm]			Order No. of strainer insert Mesh size ¹ color code			
			B	D	L	30 M	50 M	80 M	100 M
280	SGI 6R	G 1 1/2 female	146	116	353	114.06	114.03	114.08	114.02

A.345.033/A.345.033.5

High-pressure strainer,
max. 50 bar,
made of fiber glass reinforced nylon



Max. flow rate [l/min]	Order No.	Connection	Dimensions [mm]		Order No. Strainer insert (incl.)
			D	L	
150	A.345.033	G 1/2 female / G 3/4 female	104	259	50 M
150	A.345.033.5	G 1/2 female / G 3/4 female	104	259	80 M

Designation	Order No.
Accessories for high-pressure strainer, 50 bar	
Plug G 1/2	A.004.010.020
Gasket for G 1/2 plug	A.403.000.060
Plug G 3/4	A.465.230.020
Gasket for G 3/4 plug	A.465.005.140

Suction strainer

A.316.172/A.316.173

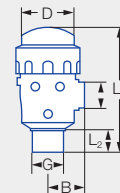

Max. flow rate [l/min]	Order No.	Connection	Dimensions [mm]				Strainer insert Mesh size ¹ color code
			B	D	L ₁	L ₂	
220	A.316.172 incl. strainer 30 M	G 2 male	98	170	292	42	30 M A.316.002.030
220	A.316.173 incl. strainer 50 M	G 2 male	98	170	292	42	50 M A.316.003.030

SGA2.300.53/SGA3.300.53

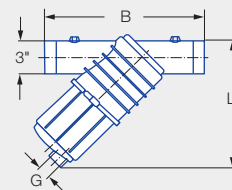

Max. flow rate [l/min]	Order No.	Connection	Dimensions [mm]		Strainer insert Mesh size ¹ color code
			B	L	
800	SGA2.300.53 incl. strainer 30 M	G 3 male	415	358	30 M 002.26
800	SGA3.300.53 incl. strainer 50 M	G 3 male	415	358	50 M 003.26

¹ Please always specify the desired mesh size when ordering!



- With 63 mm housing
- Scaling corresponds to EN 12761

Advantages

- Easy to read thanks to expanded colored scale range
- Robust against mechanical loads
- Externally adjustable pressure mark

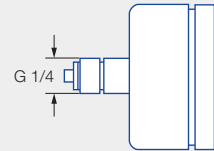
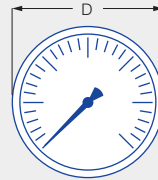

63 mm housing

Display range [bar]	Overpressure range up to ... [bar]	Connection	Scale diameter D [mm]	Version/Order No.		Strainer insert Mesh size ¹ color code
				Standard version	Liquid fertilizer-proof version	
1.0–10.0	60.0	rear	63.0	095.009.00.11.37	095.009.00.11.35²	0.2

¹ Please always specify the desired mesh size when ordering!

² Clearance.

Top Flow II

Electromagnetic flow meter



- Display of overall volume and flow rate
- Temperature range -15 °C to +65 °C
- Measuring accuracy 99%:
1": 8–400 l/min
2": 25–1,100 l/min
3": 60–2,500 l/min
- Max. pressure: 10 bar at 20 °C



Advantages

- Self-calibrating
- Independent of density and viscosity
- Simple and fast assembly via manifold and FIXLOC connection
- Suitable for UAN and plant protection products

Including the following manifold fittings:

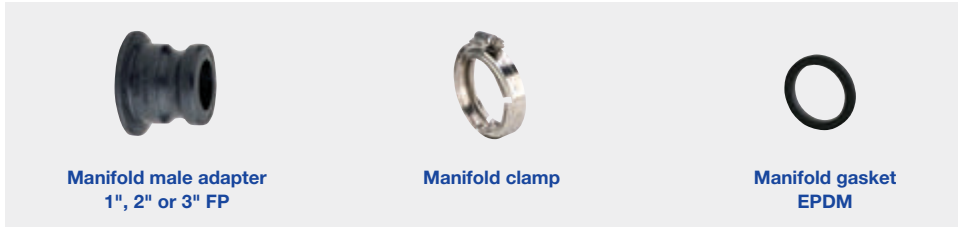

Manifold male adapter
1", 2" or 3" FP

Manifold clamp

Manifold gasket
EPDM

Designation	Order No.
1"	B.MFM.100.CO.M
2"	B.MFM.220.CO.M
3"	B.MFM.300.CO.M

Note

Please observe the installation instructions.



AirPress HP

Pneumatic pressure regulator for boom sprayers



Dimensions in mm.

- Pressure regulation via pressure chamber with air pressure

Advantages

- Large flow rate range
- Fast pressure regulation without delay
- Ideal in combination with automatic boom section and individual nozzle control
- Up to 10 bar spray pressure

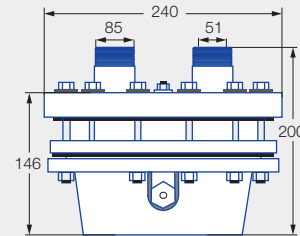

Technical data	Version 1 1/4"	Version 2"
Weight	5.4 kg	5.5 kg
Connections	G 1 1/4 male for inlet and outlet 1/4" BSP for air connection	G 2 male for inlet and outlet 1/4" BSP for air connection
Material	Nylon, polyethylene, stainless steel, NBR (optionally Viton), CR	
Pressure range	Max. 10 bar	
Pressure drop	Only 0.2 bar up to 100 l/min, approx. 0.5 bar for 250 l/min	
Max. flow rate	250 l/min	500 l/min

Designation	Order No.
1 1/4"	RC90.011.40.00.00
1 1/4" Viton	RC90.0V1.14.00.00
2"	RC90.020.00.00.00
2" Viton	RC90.0V2.00.00.00





Nozzle calculator app



Apple



Android

The Lechler agricultural nozzle app makes it easy to select the right nozzle for your application.

On the basis of the selected sprayer speed and application rate, the nozzle shows you the suitable nozzles and corresponding droplet size categories. This allows you to quickly find the suitable Lechler nozzle and thus optimize your application.

All values are based on measurements with water.

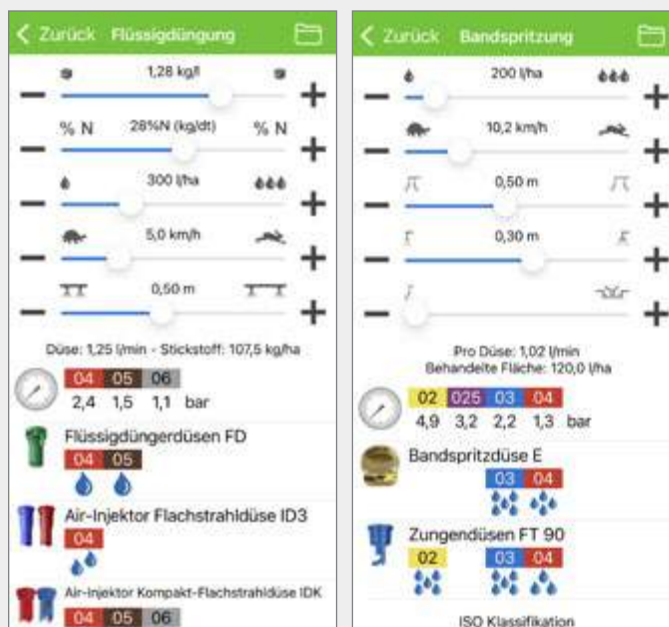

Anemometer Pocketwind IV

- Backlit display
- Waterproof and shockproof housing
- Lanyard
- Integrated hard cover for protection against damage and dirt
- Tripod thread

Advantages

- Self-calibrating humidity sensor
- Hard cover protects measuring sensors against damage
- Measures all relevant application parameters

Measuring functions

- – Relative humidity
- – Dew point
- – ΔT
- – Wet bulb thermometer
- Wind speed
 - Maximum
 - Average
 - Switchable units m/s, km/h, fpm, mph, kn and bft
- Temperature/wind chill units °C and °F, switchable
- Wind direction
 - Digital compass
 - Integrated wind vane



Order No.

Z.WIN.DME.SS.ER.010

**Droplet size calculator/
dosage calculator**

Order No.: **095.009.50.12.11.4**



Water-sensitive paper

Size: 76 x 26 mm
Order No.: **Z.WSP.76X.26.00.00.0**



Nozzle cleaning brush

Order No.: **095.009.50.10.89.0**

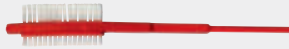

Nozzle aligner

Order No.: **065.231.02**

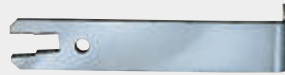

Nozzle assembly wrench

Order No.: **092.164.40.00.99.0**



Sample bag

Field crops
Order No.: **092.251.00.00.00.0 / 872585**

Viticulture, orchard and specialty crops
Order No.: **092.251.00.10.00.0 / 872586**



**Adjustment template
for Dropleg^{UL}**

Order No.: **092.163.42.10.30**

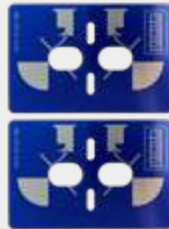

VR assembly tool

The Lechler VR assembly tool permits aligned installation of the VR stainless steel insert including gasket.
Order No.: **6VR.000.56.10.00.0**



Spray table for arable crops

DIN A4

**Spray table for arable
crops UAN**

DIN A4

**Spray table for viticulture,
orchard and specialty crops**

DIN A5



A wide-angle photograph of a golden wheat field stretching to the horizon. The sky is a deep blue with soft, white and pinkish clouds. The wheat stalks are tall and full, with their heads clearly visible. A narrow path or furrow runs through the center of the field, leading the eye towards the horizon.

RESPONSIBILITY FOR
NATURE AND ENVIRONMENT
PRECISION FROM LECHLER

**ENGINEERING
YOUR SPRAY SOLUTION**



Lechler GmbH · Precision Nozzles · Agricultural Spray Nozzles and Accessories
Ulmer Strasse 128 · 72555 Metzingen, Germany · Phone +49 7123 962-0 · info@lechler.de · www.lechler-agri.com

Edition 02/22 · EN · 1,000 · www.dgm-kommunikation.de
Subject to technical modifications or mistakes.